



**Computer
Network
Accessories, Inc.**

SECOND HALF 2009

Quality Products at Discount Prices

Power Strips



starting at
\$3⁴⁰

Network Cables

starting at
69¢



USB 2.0 Cables

starting at
69¢



Cameras



starting at
\$39⁰⁰

HDMI Cables

starting at
\$2⁹⁰



Bulk Wire



starting at
\$2⁵⁰

Computer Cables

starting at
\$1⁷⁰



DATA CABLING

CABLE
MANAGEMENT

NETWORK
HARDWARE

USB PRODUCTS

PC CABLING

HDMI CABLING

VOICE CABLING

VIDEO CABLING

AUDIO CABLING

SURVEILLANCE

TOOLS
& TESTERS

PRINTER
SUPPLIES

PC HARDWARE

INSTALLATION
PARTS

MULTIMEDIA

KEYBOARDS
& MICE



800.516.1262
www.FastComputerParts.com



Cat5e, 350 MHz Molded Patch Cables

UTP 'Ferrari' style RJ45 patch cables 350MHz RJ45-RJ45 (8P8C), UL Listed 10/100 and gigabit ethernet networks. Gold plated 50u, 24AWG stranded, round snagless 'Ferrari' molding protects the RJ45 plastic tab from damage during installation.



CNA#		1-9	10+
43-715 xx	1 ft.	1.19	.99
43-720 xx	3 ft.	1.25	1.10
43-723 xx	5 ft.	1.45	1.35
43-725 xx	7 ft.	2.10	1.75
43-727 xx	10 ft.	2.25	1.95
43-730 xx	15 ft.	3.10	2.70
43-735 xx	25 ft.	4.45	3.95
43-740 xx	50 ft.	7.90	7.40
43-742 GR	75 ft.	10.75	9.90
43-745 xx	100 ft.	14.75	13.90

XX = Use color code below

GR=Grey, BK=Black, BL=Blue, GN=Green, OR=Orange, PR=Purple, RD=Red, YL=Yellow

Shielded Cat6 Cables

High quality 50 micron gold RJ45 plugs. 4 Pair 26 AWG stranded wire. Snag-free molded boots. Gray color.



CNA#		1-9	10+
43-920	3 ft.	3.25	2.75
43-925	7 ft.	4.35	3.80
43-930	15 ft.	6.30	5.70
43-935	25 ft.	9.50	8.80
43-940	50 ft.	16.50	15.50
43-945	100 ft.	29.90	28.00

Cross Wired Cat5e Patch Cables

Great for hub to hub and machine to machine connections.

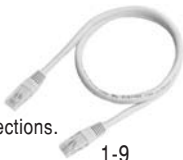

CNA#		1-9	10+
43-420	3 ft.	1.35	1.20
43-425	7 ft.	2.30	1.95
43-430	15 ft.	3.10	2.70
43-435	25 ft.	4.45	3.95
43-440	50 ft.	7.40	6.90
43-445	100 ft.	13.25	12.40

Cat6 Molded Cables

High quality RJ45 cables for applications beyond 1000 TX (Gigabit).



CNA#		1-9	10+
43-815 xx	1 ft.	1.50	1.35
43-820 xx	3 ft.	1.90	1.70
43-823 xx	5 ft.	2.25	2.05
43-825 xx	7 ft.	2.90	2.50
43-827 xx	10 ft.	3.50	3.20
43-830 xx	15 ft.	4.40	3.80
43-835 xx	25 ft.	5.90	5.40
43-840 xx	50 ft.	10.50	9.90
43-845 GR	100 ft.	18.25	17.50

110 Type Keystone Jacks



CNA#		1-9	10+
43-309 xx	RJ45, Cat5e	2.25	1.95
43-007	RJ45, Cat5e Shielded	3.75	3.35
43-312 xx	RJ45, Cat6	2.90	2.45
43-322	RJ45, Cat6 Shielded	4.45	3.95
43-008 xx	RJ11/12, Cat3	1.90	1.70

XX = Use color code below

IV=Ivory, BK=Black, BL=Blue, GN=Green, YL=Yellow, RD=Red, OR=Orange, WH=White

Tool-less Keystone Jacks



CNA#		1-9	10+
43-009 xx	RJ45, Cat5e	2.25	1.95
43-010 xx	RJ45, Cat6	3.10	2.75
43-006 xx	RJ11/12, Cat3	1.90	1.70

Keystone Modular Face Plates w/Hardware



CNA#		1-9	10+
43-220 xx	Single Cavity Plate	.79	.59
43-225 xx	Dual Cavity Plate	.79	.59
43-223 xx	Three Cavity Plate	.79	.59
43-226 xx	Four Cavity Plate	.79	.59
43-230 xx	Six Cavity Plate	.79	.59
43-239 xx	Blank Cavity Cover	.35	.25

XX = IV=Ivory, WH=White

Visit us on the web for our complete product line

www.FastComputerParts.com

800-516-1262

Fax: 800-236-5672

Loaded Surface Mount Jacks 110 Style



CNA#		1-4	5+
42-205	Cat5e, 1-Port, RJ45	2.90	2.70
42-209	Cat5e, 2-Port, RJ45	4.80	4.50
42-203	Cat5e, 8-Port, RJ45	17.25	16.50
42-305	Cat6, 1-Port, RJ45	4.40	3.90
42-309	Cat6, 2-Port, RJ45	6.50	5.90
42-301	Cat6, 8-Port, RJ45	28.50	26.50

Keystone Blank Surface Mount Boxes



CNA#		1-4	5+
42-110 XX	1-Port	.99	.79
42-111 XX	2-Port	1.25	.99
42-114 XX	3-Port	1.45	1.25

Cat5 Junction Box

Great for splicing cables.
110 Block to 110 Block.

CNA#	1-4	5+
43-538	3.40	2.90



Cat5e RJ45 Couplers

Great for extending cables.

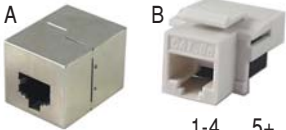

CNA#		1-4	5+
43-419	(A) Jack to Jack	2.50	2.20
43-411	(B) Jack to Jack, Keystone Cat3	2.95	2.45
43-414	(B) Jack to Jack, Keystone Style	3.15	2.50
43-429	(A) Jack to Jack, Shielded	3.90	3.40

Keystone Couplers

Snap-In bulkhead for Keystone installations.

CNA#	1-9	10+	
43-408 XX	Blank	.49	.39
43-410 XX	BNC	1.75	1.50
43-415 XX	"F"	1.75	1.50
101818 XX	S-Video	1.75	1.50



XX = IV=Ivory, WH=White

Metal Wall Plate Mounting Brackets

Eliminates the need for an electrical box for low voltage construction. Makes fishing wire much easier.

CNA#		1-4	5+
43-110	Single Bracket	2.10	1.90



Bulk Network Cable

Unshielded twisted pair,
24 AWG, 4-Pair.
UL Approved.



83-413	Cat5e, 100 MHz, Solid, 300', Gray	34.50
83-407	Cat5e, 350 MHz, Solid, 1000', Gray	79.50
83-407B	Cat5e, 350 MHz, Solid, 1000', Blue	79.50
83-408	Cat5e, 350 MHz, Stranded, 1000'	115.00
83-417	Cat5e, Shielded, Solid, 1000'	135.00
82-927	Cat5e, Plenum, Solid, 1000'	195.00
83-418	Cat6, 550 MHz, Solid, 300'	44.50
83-402	Cat6, 550 MHz, Solid, 1000'	109.00
83-406	Cat6, 550 MHz, Plenum, Solid, 1000'	269.00

Modular Data Plugs



CNA#	8P8C Cat5e, 50 Micron	1-4	5+
83-468	RJ45 Stranded 2-Prong (100 pcs)	10.40	9.90
83-368	RJ45 Solid 3-Prong (100 pcs)	14.50	13.90
83-377	RJ45 Solid Shielded 3-P (100 pcs)	26.75	25.00
CNA#	8P8C Cat6, 50 Micron		
83-469	RJ45 Solid 3-Prong (100 pcs)	20.50	19.90
CNA#	Solid Cable		
83-166	6P6C RJ12 (100 pcs)	3.90	3.60
83-168	8P8C RJ45 (100 pcs)	8.95	7.95
CNA#	Stranded Cable		
83-266	6P6C RJ12 (100 pcs)	4.60	3.90
83-268	8P8C RJ45 (100 pcs)	8.95	7.95

UTP Cat5e Plug with Quick Insert

Faster and easier installation.

CNA#	1-24	25+
83-568	.39	.36



D-Sub Modular Adapters

Assembly required.

CNA#		1-9	10+
85-209	9 Pin Male RJ45 (8x8)	1.35	.99
85-219	9 Pin Female RJ45 (8x8)	1.35	.99
85-309	25 Pin Male RJ45 (8x8)	1.35	.99
85-319	25 Pin Female RJ45 (8x8)	1.35	.99



Cross Wire Adapter

Make a standard 10 Base-T patch cable crossed for hub to hub and machine to machine applications.

CNA#	1-4	5+
43-449	2.55	2.30





USB 150Ft Extender Via Cat5 Ethernet

Allows a USB device to have its cable length extended up to 150Ft. No driver needed. Win 98SE/ME/2000/XP. Mac OS9.X/10.X.

LAN cable required: Cat.5/5E/6 150443



29.50

300Ft PS/2 Extender Via LAN Cable

Extends PS/2 Keyboard and mouse via Cat.5 cable up to 100m (330FT). No power required. 190126



48.00

300Ft SVGA Extender Via LAN Cable

Extend VGA via Cat5 STP cable. A pair/set (transmitter and receiver). Up to 300ft/135m via Cat5 STP. Supports up to 1280 x 1024 resolution. 501509



99.00

S-Video Balun via UTP Extends up to 1000Ft

RJ45 female to Mini DIN4 (S-Video) Designed for S-Video signal transmission over Cat.5 UTP cable Up 1000Ft in color via Cat.5 UTP cable No power required 202216



57.00

2 Port Network Distributor Modular RJ45

At present only 2 pairs are used in 10 Base-T wiring. The second port of this distributor wires the signal to run over the unused second pair. Use one at each end of the cable run.



CNA#	1-4	5+
43-532	4.40	3.90

DSL Modem Splitter/Filter

RJ11 Plug.

87-775	Phone/Filter Only	2.75
87-770	DSL Modem and Phone/Filter	3.50



Cat5e/6 Patch Panels

110 type wiring, Cat5e certified.

UL listed

CNA#		
43-612	12 Port T568B, 1-3/4" High (1U)	19.50
43-624	24 Port T568B, 1-3/4" High (1U)	29.00
43-648	48 Port T568B, 3-1/2" High (2U)	59.00
43-696	96 Port T568B, 7" High (4U)	129.00

Cat6 Patch Panels

43-630	12 Port T568B, 1-3/4" High (1U)	29.00
43-626	24 Port T568B, 1-3/4" High (1U)	39.00
43-632	48 Port T568B, 3-1/2" High (2U)	79.00
43-622	96 Port T568B, 7" High (4U)	159.00

12 Port Vertical Patch Panel

110 type wiring, Cat5e certified,

UL listed with mounting bracket.

CNA#		Each
43-611	Cat5e	19.00
43-621	Cat6	29.00



19" Equipment Wall Mount Brackets

CNA#

43-617	1U Hinged Wall Mount 6" Depth	9.50
43-629	2U Hinged Wall Mount 6" Depth	14.25
43-613	4U Hinged Wall Mount 6" Depth	23.50
43-614	4U Non-Hinged Wall Mount 12" Depth	31.50
43-618	7U Non-Hinged Wall Mount 12" Depth	49.25



19" Blank Panels

CNA#

43-529	1-3/4" High (1U)	9.75
43-527	3-1/2" High (2U)	11.90
43-521	5-1/4" High (3U)	13.75
43-523	7" High (4U)	14.25



Keystone Snap-In Panels

CNA#

43-512	12 Port Unloaded Panel (1U)	6.90
43-524	24 Port Unloaded Panel (2U)	7.90



Velcro Strap 1/2" Width Black, 50pc Pack

220901	6" Length	4.90
220902	9" Length	6.75



Visit us on the web for our complete product line

www.FastComputerParts.com

800-516-1262

4 Fax: 800-236-5672

Network Hubs/Switches



10/100 Base-T Switching Hubs

43-511	5-Port N-Way Auto Detect	14.50
43-503	8-Port N-Way Auto Detect	16.50
43-508	16-Port N-Way Auto Detect	34.00
43-507	24-Port N-Way Auto - Rack Mount	69.00

Gigabit Switching Hubs

43-555	5-Port Switching Hub 10/100/1000	39.00
43-558	8-Port Switching Hub 10/100/1000	59.00
43-554	2 GIGA + 24-Port Switching Hub	99.00
EN-MGS24	24-Port GIGA Managed Rack Mount	249.00

Network Interface Cards



CNA#			
87-711	PCI	10/100 Base-T, RJ45	4.90
87-726	PCI	Gigabit, RJ45, 32 Bit	11.50
87-707	USB	10/100 Base-T	16.50
87-722	PCMCIA	10/100 Base-T, RJ45	19.75

Wireless 802.11G Networking 2.4 GHz



CNA#			
87-712	54 Mbps Wireless 4 Port Router		37.00
87-700	54 Mbps USB Lan Card		13.90
87-698	54 Mbps PCI Lan Card		13.90
87-692	54 Mbps PCMCIA Lan Card		14.90
ENRXWI-G	54 Mbps Access Point/Extender		44.90
ENHWI-SG	108 Mbps Wireless 4 Port Router		44.90
ENUWI-SG	108 Mbps USB Lan Card		23.00
ENLWI-SG	108 Mbps PCI Lan Card		22.90
ENPWI-SG	108 Mbps PCMCIA Lan Card		22.90
103421	300 Mbps Wireless-N 4 Port Router		49.00
103424	300 Mbps USB Lan Card		23.50
103422	300 Mbps PCI Lan Card		23.50
103423	300 Mbps PCMCIA Lan Card		18.90
ENAT-S04	Wireless Antenna Booster		12.50

Broadband DSL/Cable Router/Firewall

This router is a cost-effective way to share a high-speed DSL/Cable connection over the LAN with simultaneous Internet access. Compatible with Windows 95/98, NT, Win2000, XP, UNIX and OS 8.0 operating systems. 10/100 Mbps auto-sensing UTP Lan port.



87-716	10/100 4-Port	27.50
--------	---------------	-------

Network Storage Devices



Access your hard drive anywhere with the Network Storage Device. Store and access with the easy to use, built-in network interface. The Network Storage Device turns your hard drive into a remote file server with FTP and SAMBA support. ENNH-NT is a very affordable network storage device. With addition of an IDE hard drive (up to 250GB), ENNH-NT instantly becomes a local document storage center for home or office. It uses EXT3 file systems, therefore, no one should ever worry about security and privacy. In addition, ENNH-NT can be used as FTP server, just configure your router to direct ftp request to this device and you are good to go!

86-790	10/100 Mbps Enclosure	119.50
ENNH-1000	10/100/1000 Mbps Enclosure	199.00

1 Port USB Print Servers

Supports Novell Netware, Unix, Windows 95, 98, NT, 2000 and XP. Easy Plug-n-Play installation, setup and diagnostics program.



CNA#		
86-769	Single Port, 10/100 Base-T, 1 USB	58.00

Wireless Multi-Protocol USB 2.0 Print Server

This compact print server can connect your network through an Access Point under the infrastructure mode, or can be used in ad-hoc mode for direct communication between PC/Notebook and print server anywhere you wish to locate USB printer services. It manages the flow of print files from your workstation or file server to its connected printers, delivering print jobs to high-performance printers much faster than a file server or a PC acting as a print server can. The USB Print Server features a Web-based configuration utility, which allows you to set up the print server through the web browser easily and quickly. It also includes a powerful software utility, PSUtility, a user-friendly program that allows you to complete further settings for the print server.



ENPSWI-G	54 Mbps, Single Port, 1 USB	119.00
----------	-----------------------------	--------

Bluetooth V1.2 Adapter

Bluetooth adapter capable of transferring wireless data up to up to 32.8 feet (~10 meter) range. It complies to the Bluetooth v1.2 specifications. Plug and Play for easy installation.



103507	Class 1	13.50
ENUBT-C2	Class 2	11.90



19" E-Z Wall Mount Cabinet

The E-Z Compact 600 series enclosures are packaged broken down in an easy to carry space saving carry box allowing for transporting in small vehicles and warehousing in a fraction of the space as a fully assembled enclosure. Installation can be done by one person in just minutes. Simply mark your mounting holes with the supplied template, mount the rear plate and assemble the pieces one by one until finished. Units are packaged in a slim box with carry handles. For 19" rack-mount equipment. Cold Rolled Steel Panels - 20 AWG. Laminated Steel - 16 AWG / Tapped with EIA Spaced #12-24. Smoked Acrylic Door, Steel Frame With Key Lock



E-Z Compact Wall Mount Cabinets

43-689 19" Ivory 7U (15"H x 20.5"W x 20"D) 199.00

43-659 19" Black 7U (15"H x 20.5"W x 20"D) 199.00

Prassembled Wall Mount Cabinets

43-688 19" Ivory 7U (15"H x 20.5"W x 20"D) 189.00

43-663 19" Black 7U (15"H x 20.5"W x 20"D) 189.00

43-660 19" Ivory 9U (18"H x 20.5"W x 20"D) 219.00

43-685 19" Black 9U (18"H x 20.5"W x 20"D) 219.00

43-682 19" Ivory 11U (22"H x 20.5"W x 20"D) 249.00

43-687 19" Black 11U (22"H x 20.5"W x 20"D) 249.00

Visit us at
www.FastComputerParts.com
for our full line of
Floor Cabinets
Starting at \$579.00



Keystone Snap-In Panels



CNA# 43-512 12 Port Unloaded Panel (1U) 6.90

43-524 24 Port Unloaded Panel (2U) 7.90

Cable Management Panel



CNA# 43-616 1-3/4" High (1U) 8.25

43-619 3-1/2" High (2U) 9.50

19" Floor Rack

"U" shaped rails 3" x 1 1/4" tapped both front and rear with EIA compliant RMS spacing Base with perforated holes for floor anchoring. Reinforced angled top brace supports. Complete with assembly hardware and set of #12-24 tapped equipment screws. Meets or exceeds EIA-310D standards. Easy to assemble.

43-674 7 ft. High, Black

139.50



Single-Sided Shelves

The Solid equipment shelves are designed for 19" rack mount widths and are made of 16 AWG steel. The 1-piece design allows for strong support.

Finished in durable black powder coat.

43-671 10.5" Cantilever Shelf (1U) 26.25

43-679 15" Cantilever Shelf (1U) 34.50



Double-Sided Shelves

The 1-piece double-sided shelves are center mounted between the upright rails of all standard 19" panel width open racks and are offered in non-ventilated and ventilated designs. Made of 16 AWG steel construction in black powder coat finish.

43-678 18" Center Shelf (2U) 49.50

43-672 25" Center Shelf (2U) 59.75



19" Rack Mount Keyboard Tray



CNA# 43-673 Keyboard Tray (3U) 79.00

19" Rack Mount Power Strip



CNA# 43-676 1U Power Strip 10 Outlets 49.50

19" Blank Panels



CNA# 43-529 1-3/4" High (1U) 9.75

43-527 3-1/2" High (2U) 11.90

43-521 5-1/4" High (3U) 13.75

43-523 7" High (4U) 14.25

Visit us on the web for our complete product line

www.FastComputerParts.com

800-516-1262

Fax: 800-236-5672

Fiber Optic Patch Cables

Multimode
62.5/125um 3.0mm



CNA#		1-4	5+
43-194	1-Meter, Simplex ST-ST	10.50	9.90
43-196	1-Meter, Duplex ST-ST	9.90	9.40
43-182	3-Meter, Duplex ST-ST	11.00	10.50
43-184	5-Meter, Duplex ST-ST	11.90	11.40
43-193	1-Meter, Duplex ST-SC	9.90	9.40
43-197	3-Meter, Duplex ST-SC	11.00	10.50
43-195	5-Meter, Duplex ST-SC	11.90	11.40
43-199	1-Meter, Duplex SC-SC	9.90	9.40
43-186	3-Meter, Duplex SC-SC	11.90	11.40
43-183	5-Meter, Duplex SC-SC	12.90	12.40
43-203	1-Meter, Duplex LC-LC	14.90	14.00
43-187	3-Meter, Duplex LC-LC	15.90	15.00
43-201	5-Meter, Duplex LC-LC	15.90	15.00
43-205	1-Meter, Duplex LC-SC	12.90	12.40
43-198	3-Meter, Duplex LC-SC	14.90	14.00
43-192	5-Meter, Duplex LC-SC	14.90	14.00
102744	1-Meter, Duplex LC-MTRJ	16.00	14.75
102746	3-Meter, Duplex LC-MTRJ	16.00	14.75
102747	5-Meter, Duplex LC-MTRJ	16.00	14.75
102748	1-Meter, Duplex MTRJ-MTRJ	16.00	14.75
102750	3-Meter, Duplex MTRJ-MTRJ	17.75	16.50
102751	5-Meter, Duplex MTRJ-MTRJ	19.75	18.50

Fiber Optic Adapters



CNA#		1-4	5+
43-189	(A) Duplex ST-SC	2.50	2.20
43-188	(B) Duplex SC-SC	2.50	2.20
43-181	(C) Simplex ST-SC	2.60	2.08
43-185	(D) Simplex SC-SC	1.90	1.52
43-180	(E) Simplex ST-ST	1.77	1.42

Fast Ethernet Media Converter

IEEE802.3 10/100Base-TX & FX, N-way with Flow control.

Copper Connector: RJ45
Cat.5 or better, Max 100m

Fiber type: MultiMode (50 or 62.5/125)

Dimensions : 120 x 80 x 23mm

Power supply included, 12V 0.8A

102503 SC 2Km Multi-Mode to 10/100BaseTX **49.00**



KVM Switches

Mouse and keyboard emulation for automatic PC boot up. Selects any computer by Hot Keys and buttons. Great for computer rooms, access file servers via one console.



CNA#		
89-738	2 Ports, PS/2, Compact with Audio	32.00
	Two 6' PS/2 KVM & Audio Cables Built-in	
89-730	2 Ports, PS/2, Compact	26.50
	Two 6' PS/2 KVM & Audio Cables Built-in	
89-717	4 Ports, PS/2, Compact	39.00
	Requires (4) SVGA M-M, (4) PS/2 M-M Cables	
89-725	2 Ports, PS/2, Desktop	34.00
	Requires (2) SVGA M-M, (2) PS/2 M-M Cables	
89-720	4 Ports, PS/2, Desktop	59.00
	Requires (4) SVGA M-M, (4) PS/2 M-M Cables	
190121	2 Ports, PS/2 & USB Compact	35.90
	Two 6' Video & USB Cables Built-in	
190118	2 Ports, PS/2 & USB Compact	49.50
	Requires (2) SVGA M-M, (2) USB A to B Cables	
190119	4 Ports, PS/2 & USB Compact	69.50
	Requires (4) SVGA M-M, (4) USB A to B Cables	
190108	2 Ports, PS/2,USB & Audio Desktop	86.00

www.FastComputerParts.com

3 in 1 KVM Cables

High Resolution
UL 2919 3+9 Coaxial



CNA#		1-4	5+
85-080	6' SVGA M-F, PS/2 M-M Dual	8.50	7.90
85-092	6' SVGA M-M, PS/2 M-M Dual	8.50	7.90
85-075	10' SVGA M-F, PS/2 M-M Dual	10.75	9.90
85-084	10' SVGA M-M, PS/2 M-M Dual	10.75	9.90
85-061	15' SVGA M-F, PS/2 M-M Dual	13.75	12.90
85-065	15' SVGA M-M, PS/2 M-M Dual	13.75	12.90
85-071	25' SVGA M-F, PS/2 M-M Dual	19.90	18.90
85-078	25' SVGA M-M, PS/2 M-M Dual	19.90	18.90
87-708	USB to (2) PS/2 Females	5.90	5.90

VGA Video Multiplier

Send your PC's video output to as many as eight monitors with the ability to daisy chain more.

Transmission distance: 210 feet (65M).

89-731	(4 Way)	34.50
89-739	(8 Way)	49.00





Impact Punch Down Tools

Adjustable spring loaded impact mechanism.

Reversible clip-in blade.

CNA#		Each
84-816	Handle with 110 Blade	24.50
84-818	Handle with 66 Blade	24.50
84-810	110 Blade Only	7.90
84-812	66 Blade Only	7.90



110 Style Punch Tool

CNA#		1-4	5+
43-400		3.90	3.40



RJ45 Modular Crimping Tool

Hardened steel construction with cushion-grip handles. Separate cutting and stripping blades.

83-509		6.80
--------	--	------



Deluxe Modular Crimp tool

All-in-one tool. Cut, strip, and crimp telephone cable.

RJ11 with 2, 4, & 6 position.

RJ45 with 8 position. Fully ratcheted.

84-117		19.75
--------	--	-------



24' Fiberfish Kit

Fiberfish are 1/4" fiberglass nonconductive rods for fishing wire in existing walls and attics or across drop ceilings. Rods screw together to make longer lengths. Kit includes: (2) 6' male to female rods, (1) 6' male to male rod, (2) 3' male to female rods, (2) fish tips, and carrying case.

84-106		89.25
--------	--	-------



Tone Generator & Probe

The Tone Generator & Probe can be used to verify cable continuity, identify wiring faults, determine line polarity and voltage in network and modular telephone lines.

78-035		49.00
--------	--	-------



Network Cable Tester

This cable tester is designed to quickly test by auto scanning the wires continuity, miswiring and polarization of 10/100 Base-T (UTP/STP), AT&T 285A, TIA 568A/B. By using the remote terminator, you can easily test cables before or after installation.



14.50

LAN Identification Cable Tester

An essential tool for verifying and troubleshooting local area networks. The compact designed provides optimal convenience and portability!

84-857		158.00
--------	--	--------



Network Installation Kit

Includes: Remote networking cable tester for checking continuity, miswiring and polarization of 10/100 Base-T cables. Deluxe combo crimping tool for RJ11/RJ45 connectors. Impact punch down tool with 110 and 66 blades.



98.00

D-Sub Modular Adapters

Assembly Required

CNA#		1-9	10+
85-207	9 Pin Male RJ11/12 (6x6)	1.35	.99
85-209	9 Pin Male RJ45 (8x8)	1.35	.99
85-217	9 Pin Female RJ11/12 (6x6)	1.35	.99
85-219	9 Pin Female RJ45 (8x8)	1.35	.99
85-227	15 Pin Male RJ11/12 (6x6)	1.35	.99
85-237	15 Pin Male RJ45 (8x8)	1.35	.99
85-229	15 Pin Female RJ11/12 (6x6)	1.35	.99
85-239	15 Pin Female RJ45 (8x8)	1.35	.99
85-307	25 Pin Male RJ11/12 (6x6)	1.35	.99
85-309	25 Pin Male RJ45 (8x8)	1.35	.99
85-317	25 Pin Female RJ11/12 (6x6)	1.35	.99
85-319	25 Pin Female RJ45 (8x8)	1.35	.99



D-Sub Installation Tools

CNA#		1-4	5+
85-212	D-Sub and Butt connectors.	8.90	8.13
85-200	Insertion/Extraction Tool	2.25	1.93



Visit us on the web for our complete product line

www.FastComputerParts.com

800-516-1262

Fax: 800-236-5672

BNC Male 3 Piece Crimp-On

CNA#		1-24	25+
82-145	RG58	.59	.54
82-143	RG59/62	.55	.49
82-140	RG59/62 Teflon	.98	.78



BNC Male 2 Piece Crimp-On

CNA#		1-24	25+
82-147	RG58	1.00	.80
82-138	RG6	1.00	.80
82-139	RG59/62	.85	.68



BNC Male Terminators 1%, 1/2-Watt

CNA#		1-24	25+
82-176	50 - Ohm	1.23	.98
82-408	50 - Ohm with Chain	1.23	.98
82-178	75 - Ohm	1.23	.98
82-180	93 - Ohm	1.23	.98



BNC Male Twist-On

CNA#		1-24	25+
82-146	RG-58	.92	.74
82-142	RG59/62	.92	.74



BNC Adapters

CNA#		Fig.	1-9	10+
82-158	BNC Right Angle Jack-Plug	A	2.20	1.76
82-155	BNC Tee Jack-Plug-Jack	B	.89	.79
82-160	BNC Coupler Jack-Jack	C	.49	.45
82-281	BNC Bulkhead Jack-Jack	D	1.75	1.50
82-282	BNC Right Angle Jack-Plug-Jack	E	3.95	3.75



High Quality RG58 Coaxial Cable, 1000' Roll

82-920	50-Ohm Cable. AWG 20 Solid Copper Core 40% Shield Coverage. PE Insulator.	69.60
82-925	50-Ohm Cable. AWG 20 Solid Copper Core, 95% Shield Coverage. PE Insulator.	99.50



Ratchet Type Cable Crimping Tool

8 1/2" Hex crimp tool for RG58, RG59, RG62 fittings and center pin. Full cycle ratchet mechanism.
84-116 19.40



Cable Crimping Tool

8 1/2" Hex Crimp Tool for RG58, RG59, RG62 and Center Pin with adjustment.
84-010 13.90



Coaxial Stripping Tool

Rotary coaxial-stripper for RG58 and RG59. Provides quick and accurate cutting of cable jacket, shield and insulation.
84-200 9.90



UPT Jacket Stripper

Universal stripping tool for multi-conductor cable from 3.5mm to 9mm max. Great for UTP cables.
84-300 9.90



BNC Cables RG58 Molded 50 ohms

CNA#		1-9	10+
82-745	3-Foot - Male to Male	2.15	1.80
82-530	10-Foot - Male to Male	3.45	2.95
82-740	25-Foot - Male to Male	6.30	5.90
82-750	50-Foot - Male to Male	9.60	8.90
82-760	100-Foot - Male to Male	15.65	14.40



BNC Wall Plates Stainless Steel

CNA#		1-9	10+
85-281	BNC Single - Flush Mount	1.95	1.56
85-282	BNC Dual - Flush Mount	1.95	1.56





USB 2.0 Cables



CNA#		1-4	5+
85-582xx	3' A to B	1.35	1.10
85-598xx	3' A to A	1.35	1.10
150109xx	3' A to A M-F Extension	1.35	1.10
85-594	3' A to Mini 4 Pin	1.90	1.60
85-592	3' A to Mini 5 Pin	1.90	1.60
85-580xx	6' A to A	1.40	1.20
85-588xx	6' A to A M-F Extension	1.60	1.40
85-587xx	6' A to B	1.35	1.10
85-599	6' A to Mini 4 Pin	2.10	1.80
85-591	6' A to Mini 5 Pin	3.00	2.10
85-589xx	10' A to A	2.40	2.25
85-583xx	10' A to A M-F Extension	2.05	1.75
85-581xx	10' A to B	1.90	1.70
85-586	10' A to Mini 5 Pin	2.90	2.50
85-593xx	15' A to A	2.60	2.30
85-584	15' A to A M-F Extension	3.60	3.30
85-590xx	15' A to B	3.90	3.50
85-585	15' A to Mini 5 Pin	5.40	4.90
85-595xx	6' A to B	3.90	3.60

XX = Use color code below
 IV=Ivory, BK=Black, CL=Clear,
 BL=Blue, GN=Green, RD=Red

16' USB 2.0 Active Extension Cable

Extends the cable length of a USB device by 16 feet. Connect up to 5 cables in series for up to an additional 80 feet. 100% compatible with USB electrical and timing specifications.



12.75

USB Gender Changers



CNA#		1-4	5+
85-662	Type A Female to Type B Female	1.90	1.60
85-668	Type A Female to Type B Male	1.90	1.60
85-665	Type A Male to Type B Female	1.90	1.60
85-682	Type A Female to Type A Female	1.90	1.60
85-660	Type A Male to Type A Male	1.90	1.60
85-644	Type B Female to Type B Female	1.90	1.60
85-637	Type B Male to Type B Male	1.90	1.60

PS/2 to USB Active Adapter

PS/2 mouse and keyboard for connection to USB port.
87-708 5.90



6' USB to Printer Cables

CNA#		
85-673	USB to Centronics 36 Male	10.90
85-634	USB to DB25 Female	12.90



USB to Serial Converter

USB to Serial converter provides an easy way to connect RS232 interface peripherals to a host PC USB port or hub. Great for modems and serial printers.



85-690	1' USB to DB9 Male	11.90
85-677	6' USB to DB9 Male	13.90
85-675	6' USB to DB25 Male	19.50

USB 2.0 to IDE Adapter

Now you can add an IDE storage device to any PC USB port. Supports ATA/ATAPI CD-ROM, CD-R, CD-RW and PD Device drive. Fast installation, hot swappable and fully compliant with Plug and Play. Simple solution for USB storage.



87-884	2.5", 3.5" and 5.25" IDE	14.75
87-887	2.5", 3.5" and 5.25" SATA	18.50
150445	2.5", 3.5", 5.25" IDE and SATA	22.50

5Ft USB Extension Stand

85-597BK	Black	2.90
85-597BL	Blue	2.90
85-597WH	White	2.90



USB 150Ft Extender Via Cat5 Ethernet

Allows a USB device to have its cable length extended up to 150Ft. No driver needed. Win 98SE/ME/2000/XP. Mac OS9.X/10.X. LAN cable required: Cat.5/5E/6
150443 29.50



Visit us on the web for our complete product line

www.FastComputerParts.com

800-516-1262

10 Fax: 800-236-5672

USB 2.0 Hubs

Plug and Play with USB devices.



CNA#			
87-999	4 Port Non-Powered Mini		6.50
87-988	7 Port Powered		13.50

64-In-1 USB 2.0 Memory Card Reader

Compact Flash, Secure Digital, Multimedia, Memory Stick, Smart Media, MicroDrive and More.



87-226	CF/SD/MMC/MS/SM/MD		9.90
--------	--------------------	--	------

USB2.0 to VGA Adapter

The USB2.0 VGA adapter enables you to connect any monitor, LCD projector to your PC or notebook. View your large spread sheet across two screens with display continuity. Multitask more effectively without overlapping windows. Resolution supported up to 1280X1024



150446			49.50
--------	--	--	-------

USB Color Camera Kit

Capture and email stills and videos. Add live images to your instant messages. Play Cool Camera Games. USB for true plug and play setup.



85-997			12.50
--------	--	--	-------

FireWire 3 Port Repeater Hub

The IEEE 1394 Repeater Hub is what you want if you need to connect more FireWire peripherals over a long distance. This also allows a single FireWire cable to extend its length from 15 to 225 feet via one repeater hub to another.



160701			38.50
--------	--	--	-------

1394 FireWire Cables



CNA#			1-4	5+
85-688	3'	4 Pin to 4 Pin	2.80	2.40
85-684	3'	6 Pin to 4 Pin	2.80	2.40
85-689	3'	6 Pin to 6 Pin	2.80	2.40
85-685	6'	4 Pin to 4 Pin	3.40	2.90
85-680	6'	6 Pin to 4 Pin	3.40	2.90
85-683	6'	6 Pin to 6 Pin	3.40	2.90
85-681	10'	4 Pin to 4 Pin	4.30	3.80
85-686	10'	6 Pin to 4 Pin	4.30	3.80
85-687	10'	6 Pin to 6 Pin	4.30	3.80

Manual USB Switches

Works with USB1.1 or 2.0



CNA#			
150428	A Type Female x 1 & B Type Male x 2		12.90
150429	A Type Female x 1 & B Type Male x 4		14.90

USB/FireWire/RJ45/RJ11 14PC Travel Kit

Forget to bring a cable with you? USB, FireWire, RJ45, RJ11, Digital Camera, USB Printer or Modem your are covered with this kit. Even includes a microphone and headset.



150451			17.90
--------	--	--	-------

USB2.0 Docking Station

Using only one USB port from your PC or Laptop you can add (2) USB Ports, (1) USB File Transfer Port, (2) PS/2 Ports, (1) DB9 Serial Port, (1) DB25 Parallel Port and (1) RJ45 LAN Port



150426			88.00
--------	--	--	-------

USB Phone

USB1.1 & 2.0, no extra power or sound card needed. Supports recording voice into WAV file. Works with Skype and most VoIP software.



150439			19.75
--------	--	--	-------

PC to PC USB Data Bridge

The PC Bridge adapter is your fast solution to peer-to-peer file transfer between two computers via the USB port. The PC Bridge provides true plug-n-play capability while transferring files at much greater speeds than traditional file transfer products via serial or parallel port.



87-703	USB2.0		14.50
--------	--------	--	-------

USB 2.0 Flash Drives

Carry your important files with you (drivers, MP3 files, etc.). Ideal for data transfer, storage and back up. Convenient, compact, durable and self-powered. Windows® 98/SE/ME/2000/XP, Mac and Linux.



87-241	2 GB		9.90
87-244	4 GB		14.90
87-252	8 GB		19.50
87-253	16 GB		29.50



USB 2.0 Flash Drives

Carry your important files with you (drivers, MP3 files, etc.). Ideal for data transfer, storage and back up. Convenient, compact, durable and self-powered. Windows® 98/SE/ME/2000/XP, Mac and Linux.



87-241	2 GB	9.90
87-244	4 GB	14.90
87-252	8 GB	19.50
87-253	16 GB	29.50

USB 2.0 Pen Drive Card Readers

Turn your memory into a Pen Drive! No drivers are required making it easy to use in any computer with an available USB port. No external power required.



87-249	SD/MMC/RS	5.90
87-247	MS/MS-DUO/MS-PRO	5.90
87-246	SD/TransFlash	6.50

Flash Memory



CNA#		
87-737	2 GB, Micro SD w/ SD Adapter	9.50
87-761	4 GB, Micro SD w/ SD Adapter	12.90

USB TV Tuner and Capture Box

USB2.0 TV Box is the newest TV receiving and video capturing device designed for Notebook and PCs. It can make your computer a mobile TV station and enable you to enjoy wonderful TV programs anytime and anywhere. This captures video 704 x 480 (NTSC) resolutions, creating high quality video that can be stored on a PC hard disk via USB 2.0/1.1. Users can watch video on the PC, while also capturing video to the hard disk drive of their notebook PC.



87-512	TV Tuner & Capture Box	29.75
--------	------------------------	-------

USB HDTV Tuner Pen Drive

This is a Mini Digital USB HDTV Tuner that allows you to use your computer as a TV and digital multimedia center. This Mini and compact design makes it easy and portable to take along with you wherever you go. Enjoy free air HDTV and Analog TV (cable or air) entertainment whenever you like and wherever you go.



87-515	Digital HDTV & Analog TV Tuner	54.75
--------	--------------------------------	-------

PS/2 Cables



CNA#		1-9	10+
85-175	6' Male to Female	1.50	1.20
85-136	6' Male to Male	1.50	1.20
85-134	10' Male to Female	1.95	1.60
85-176	10' Male to Male	1.95	1.60
85-171	15' Male to Female	2.80	2.40
85-165	15' Male to Male	2.80	2.40
85-191	25' Male to Female	3.30	2.80
85-188	25' Male to Male	3.30	2.80
85-095	50' Male to Female	4.90	4.50
85-093	50' Male to Male	4.90	4.50

Keyboard Adapters



CNA#		1-4	5+
85-640	Din 5 Male to Mini Din 6 Female	.95	.85
85-642	Din 5 Female to Mini Din 6 Male	.95	.85

Mouse Adapters



CNA#		1-4	5+
85-643	Mini Din 6 Female to DB9 Female	1.55	1.28
85-646	Mini Din 6 Male to DB9 Male	1.55	1.28
85-647	Mini Din 6 Female to DB9 Male	1.44	1.18
85-648	Mini Din 6 Male to DB25 Male	2.45	2.20

300Ft PS/2 Extender Via LAN Cable



Extends PS/2 Keyboard and mouse via Cat.5 cable up to 100m (330FT). No power required.

190126		48.00
--------	--	-------

PS/2 "Y" Cable

6 Pin Mini Din Male to two 6 Pin Mini Din Females.



CNA#		1-4	5+
85-199		2.40	2.10

Mouse and Monitor "Y" Cable



CNA#		1-4	5+
85-177	DB15HDMaleto2DB15HDFemales	3.25	2.90

Visit us on the web for our complete product line

www.FastComputerParts.com

800-516-1262

12 Fax: 800-236-5672

Monitor and Serial Cables



CNA#		1-9	10+
85-116	6' DB9 (Male to Female)	2.15	1.85
85-113	6' DB9 (Male to Male)	2.15	1.85
85-144	10' DB9 (Male to Female)	2.80	2.40
85-143	10' DB9 (Male to Male)	2.80	2.40
85-167	15' DB9 (Male to Female)	3.40	2.90
85-161	15' DB9 (Male to Male)	3.40	2.90
85-130	25' DB9 (Male to Female)	4.40	3.90
85-151	25' DB9 (Male to Male)	4.40	3.90
85-090	50' DB9 (Male to Female)	6.40	5.90

SVGA Monitor Cables

85-138	6' DB15(HD) Male to Female	2.30	1.90
85-141	6' DB15(HD) Male to Male	2.30	1.90
85-149	10' DB15(HD) Male to Female	3.40	2.90
85-162	10' DB15(HD) Male to Male	3.40	2.90
85-168	15' DB15(HD) Male to Female	4.40	3.90
85-163	15' DB15(HD) Male to Male	4.40	3.90
85-166	25' DB15(HD) Male to Female	5.40	4.90
85-169	25' DB15(HD) Male to Male	5.40	4.90

www.FastComputerParts.com

Plenum High Resolution VGA DB15 Monitor/Projector Cables



CNA#		Each
85-043	25' Male to Male	99.50
85-035	25' Male to Female	99.50
85-052	50' Male to Male	159.50
85-036	50' Male to Female	159.50
85-039	100' Male to Male	235.00
85-046	100' Male to Female	235.00
85-037	125' Male to Male	275.50
85-042	125' Male to Female	275.50
85-033	150' Male to Male	347.00
85-050P	150' Male to Female	347.00
85-038	175' Male to Male	395.50
85-030	175' Male to Female	395.50
85-032	200' Male to Male	439.00
85-054	200' Male to Female	439.00

3 RCA Component Monitor Cable

DB15(HD) Male to 3 RCA Males



CNA#		1-4	5+
201970	6Ft.	5.90	5.50
201971	12Ft.	6.90	6.40
201972	25Ft.	9.95	9.25

Super VGA UL2919 3 Coax Monitor Cables DB15(HD)



CNA#		1-4	5+
85-174	6' Male to Male	5.50	5.10
85-173	6' Male to Female	5.50	5.10
85-081	10' Male to Male	7.50	6.90
85-085	10' Male to Female	7.50	6.90
85-182	15' Male to Male	9.50	8.90
85-187	15' Male to Female	9.50	8.90
85-189	25' Male to Male	12.20	11.50
85-190	25' Male to Female	12.20	11.50
85-192	50' Male to Male	20.90	19.90
85-195	50' Male to Female	20.90	19.90
85-210	75' Male to Male	30.90	28.90
85-214	75' Male to Female	30.90	28.90
85-222	100' Male to Male	39.50	37.00
85-213	100' Male to Female	39.50	37.00

High Resolution VGA DB15 Monitor Cables w/Audio



CNA#		1-4	5+
85-060	3' Male to Male	6.90	6.50
85-069	3' Male to Female	6.90	6.50
85-064	6' Male to Male	9.90	9.50
85-072	6' Male to Female	9.90	9.50
85-070	10' Male to Male	12.50	11.90
85-082	10' Male to Female	12.50	11.90
85-083	15' Male to Male	16.00	15.40
85-074	15' Male to Female	16.00	15.40
85-073	25' Male to Male	22.90	22.00
85-066	25' Male to Female	22.90	22.00
85-067	50' Male to Male	39.90	38.50
85-062	50' Male to Female	39.90	38.50

300Ft SVGA Extender Via LAN Cable



Extend VGA via Cat5 STP cable. A pair/set (transmitter and receiver). Up to 300ft/135m via Cat5 STP. Supports up to 1280 x 1024 resolution. 501509

99.00

5 RCA Component Monitor Cable

DB15(HD) Male to 5 RCA Males



CNA#		1-4	5+
201975	6Ft.	10.50	9.90
201977	25Ft.	22.25	21.50

800-516-1262

www.FastComputerParts.com



Manual Switch Boxes



CNA#		1-4	5+
85-853	DB-25 Female Two Way	6.75	6.25
85-873	DB-25 Female Four Way	10.80	9.90
85-867	DB-25 IEEE Female Two Way	7.80	6.90
85-871	DB-25 IEEE Female Four Way	9.25	8.50
85-866	Centronics Female Two Way	6.70	5.90
85-858	Centronics Female Four Way	13.90	12.80
85-875	DB-9 Female Two Way	9.25	8.50



85-855	RJ11/12 Two Way	6.50	5.90
85-877	RJ11/12 Four Way	11.75	9.90



85-863	SVGA/Keyboard(5P) 4-Way	14.50	14.00
--------	-------------------------	-------	-------



85-860	SVGA/Keyboard(5P)/Mouse 2-Way	13.25	12.50
85-868	SVGA/Keyboard(5P)/Mouse 4-Way	18.90	17.90



85-869	SVGA/Keyboard/Mouse 2-Way	13.75	12.90
85-862	SVGA/Keyboard/Mouse 4-Way	20.20	19.50



85-876	USB (1A + 2B) 2-Way	10.25	9.50
85-874	USB (1A + 4B) 4-Way	11.90	10.90
85-879	USB (1B + 2A) 2-Way	10.25	9.50
85-854	USB (1B + 4A) 4-Way	11.90	10.90

Power Free Auto Switch Boxes



CNA#		1-4	5+
89-705	Parallel Auto, 2 Position	11.25	9.88
89-703	Parallel Auto, 4 Position	17.25	16.50

Keyboard Adapters



CNA#		1-4	5+
85-640	Din 5 Male to Mini Din 6 Female	.95	.85
85-642	Din 5 Female to Mini Din 6 Male	.95	.85

Keyboard Adapters



CNA#		1-4	5+
85-641	Din 5 M to Mini Din 6 F	1.55	1.20
85-645	Din 5 F to Mini Din 6 M	1.55	1.20

USB to PS/2 Adapters



CNA#		1-4	5+
85-639	PS/2 Male to USB A Female	2.25	1.90

Thinkpad "Y" Cable

Connect a mouse and a keyboard to your laptop computer. 6 Pin Mini Din Male to (2) 6 Pin Mini Din Female.



CNA#		1-4	5+
85-193		2.75	2.40

Null Modem Adapter



CNA#		1-9	10+
85-345	25 Pin M-F	2.10	1.50

Loop Back Tester



CNA#		1-4	5+
78-062	Serial (DB25F and DB9F)	5.85	5.50

Visit us on the web for our complete product line

www.FastComputerParts.com

800-516-1262

14 Fax: 800-236-5672

HDMI Cables

1080P Compatible



CNA#		1-4	5+
72-772	3' (1M) HDMI Male to Male	3.50	2.90
72-776	6' (2M) HDMI Male to Male	5.60	4.90
72-771	9' (3M) HDMI Male to Male	8.80	7.90
72-770	16' (5M) HDMI Male to Male	9.90	9.00
181205	22' (7M) HDMI Male to Male	10.50	9.50
181206	30' (10M) HDMI Male/Male	12.90	11.90
181207	50' (16M) HDMI Male/Male	75.00	72.50
181208	75' (25M) HDMI Male/Male	82.00	79.00
181209	100' (30M) HDMI Male/Male	129.50	125.00
181210	150' (50M) HDMI Male/Male	144.50	139.00
72-775	3' (1M) HDMI Male to DVI	7.50	6.90
72-779	6' (2M) HDMI Male to DVI	9.90	9.20
72-774	9' (3M) HDMI Male to DVI	10.90	10.20
72-781	16' (5M) HDMI Male to DVI	15.75	14.25
181215	22' (7M) HDMI Male to DVI	21.50	20.00
181216	30' (10M) HDMI Male to DVI	24.50	23.00

HDMI Adapters



CNA#		1-4	5+
181240	HDMI Male to DVI Female	6.50	5.90
181241	HDMI Female to DVI Male	6.50	5.90
181242	HDMI Female to Female	5.90	5.50

HDMI Switches w/Remote

The HDMI Switcher allows access to multiple HDMI devices.



110301	2 Way Switch	59.00
110303	4 Way Switch	79.00

www.FastComputerParts.com

High Performance 3 RCA Component Video Cables



CNA#		1-9	10+
72-920	3' Black - 3 RCA	5.90	5.40
72-906	6' Black - 3 RCA	8.90	8.40
72-922	12' Black - 3 RCA	12.40	11.75
72-925	25' Black - 3 RCA	16.90	15.90
72-950	50' Black - 3 RCA	33.00	31.75
72-975	75' Black - 3 RCA	39.90	37.90
72-940	100' Black - 3 RCA	49.90	47.75

Mini Gender Changers



CNA#		1-9	10+
85-331	9 Pin Mini M-M	1.55	1.10
85-336	9 Pin Mini F-F	1.55	1.10
85-430	15 Pin(SVGA) Mini M-M	2.45	1.90
85-435	15 Pin(SVGA) Mini F-F	2.45	1.90
85-433	15 Pin(SVGA) M-F (Port Saver)	2.45	1.90
85-351	25 Pin Mini M-M	1.65	1.40
85-356	25 Pin Mini F-F	1.65	1.40
85-338	25 Pin Mini M-F (Port Saver)	1.65	1.40

Serial Port Adapters



CNA#		1-9	10+
85-440	DB9 F - DB25 M	1.10	.96
85-777	DB9 M - DB25 F	1.10	.96
85-891	DB9 F - DB25 F	1.20	1.05
85-890	DB9 M - DB25 M	1.20	1.05

DB25 Jumper Box

Use to permanently configure a RS232 to your application M-F.



CNA#		1-4	5+
85-788		2.90	2.60

6' DVI Monitor Cables



CNA#		1-4	5+
85-967	DVI-D Dual to DVI-D Dual	10.25	9.50
85-965	DVI-D Single to DVI-D Single	10.25	9.50
85-968	DVI-D Single to VGA (HD15M)	10.50	9.90
85-963	DVI-I Single Analog/Digital	13.50	12.75
85-966	DVI-A to VGA (HD15M)	8.50	7.90
85-969	DVI-A to DVI-A	11.50	10.75

DVI Monitor Adapters



CNA#		1-4	5+
85-962	DVI-D Dual to DFP	7.25	6.50
85-961	DVI-I Dual to VGA (HD15M)	6.25	5.75
85-964	DVI-I to VGA (HD15F)	7.90	7.25



IEEE 1284 Printer Cable

IEEE specifies the signalling method for a PC's bi-directional parallel peripheral interface.



CNA#		1-4	5+
78-805	6' DB25M to Cent 36M	5.25	4.75
78-807	10' DB25M to Cent 36M	9.90	9.40
78-811	15' DB25M to Cent 36M	11.40	10.90
78-804	25' DB25M to Cent 36M	14.50	13.90
78-810	50' DB25M to Cent 36M	19.90	19.40

Bi-Directional Parallel Printer Cables

For use with laser printers, switch boxes, etc.



CNA#		1-9	10+
78-801	6 Foot, 25 Wire	3.40	2.95
78-802	10 Foot, 25 Wire	3.90	3.40
78-803	15 Foot, 25 Wire	4.90	4.40
78-808	25 Foot, 25 Wire	7.40	6.90
85-076	50 Foot, 25-Wire	12.40	11.90
85-079	100 Foot, 25 Wire	19.75	18.50
85-146	6 Foot, Right Angle, 25 Wire	3.75	2.90

FastComputerParts.com

HP (Half-Pitch)

IEEE 1284 Printer Cable

IEEE specifies the signalling method for a PC's bi-directional parallel peripheral interface.



CNA#		1-4	5+
78-806	6' DB25M to HP Cent 36M	7.50	6.90

USB 2.0 Cables



CNA#		1-4	5+
85-582 XX	3' A to B	1.35	1.10
85-588 XX	6' A to A M-F Extension	1.60	1.40
85-587 XX	6' A to B	1.35	1.10
85-583 XX	10' A to A M-F Extension	2.05	1.75
85-581 XX	10' A to B	1.90	1.70
85-584	15' A to A M-F Extension	3.60	3.30
85-590 XX	15' A to B	3.90	3.50

XX -- IV=Ivory, BK=Black

Molded DB25 Cables

(Male to Male) (Male to Female)



Description	CNA#	CNA#	1-9	10+
6-Foot Data Cable, 25-Wires	85-612	85-712	2.35	1.90
10-Foot Data Cable, 25-Wires	85-614	85-714	3.15	2.70
15-Foot Data Cable, 25-Wires	85-624	85-725	4.10	3.50
25-Foot Data Cable, 25-Wires	85-628	85-722	5.40	4.90
50-Foot Data Cable, 25-Wires	85-638	85-738	8.40	7.90
100-Foot Data Cable, 25-Wires	85-658	85-758	19.90	18.90

IEEE 1284 DB25 Cables

(Male to Male) (Male to Female)



Description	CNA#	CNA#	1-9	10+
6-Foot Data Cable, 25-Wires	85-601	85-701	3.90	3.40
10-Foot Data Cable, 25-Wires	85-605	85-705	5.40	4.90
15-Foot Data Cable, 25-Wires	85-608	85-708	6.50	5.90
25-Foot Data Cable, 25-Wires	85-610	85-702	10.25	9.50
50-Foot Data Cable, 25-Wires	85-613	85-709	17.90	16.90

6' Null Modem Molded Cables



CNA#		1-9	10+
85-205	DB-9 Female to DB-25 Male	2.63	2.33
85-164	DB-9 Female to DB-9 Female	2.30	1.95
85-202	DB-25 Male to DB-25 Male	2.63	2.33
85-203	DB-25 Male to DB-25 Female	2.30	1.95

Modem Cables

DB-9 Female to

DB-25 Male



CNA#		1-4	5+
85-517	6'-DB-9 Female to DB-25 Male	3.25	2.80
85-519	10'-DB-9 Female to DB-25 Male	3.45	2.98

Visit us on the web for our complete product line

www.FastComputerParts.com

800-516-1262

10 Fax: 800-236-5672

RACEWAY

Raceway with Adhesive Backing

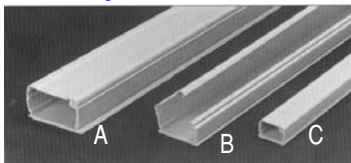

	Description	Size	CNA#	1-9	10up
C	6 Ft. Raceway Section	3/4"	43-757	6.75	<u>6.25</u>
B	6 Ft. Raceway Section	1-1/4"	43-117	10.10	<u>9.50</u>
A	6 Ft. Raceway Section	1-3/4"	43-177	13.40	<u>12.90</u>
D	Flat 90° Elbow & Base	3/4"	43-753	1.95	<u>1.60</u>
D	Flat 90° Elbow & Base	1-1/4"	43-113	2.15	<u>1.80</u>
D	Flat 90° Elbow & Base	1-3/4"	43-173	2.25	<u>1.99</u>
E	Inside Corner & Base	3/4"	43-754	1.95	<u>1.60</u>
E	Inside Corner & Base	1-1/4"	43-114	2.15	<u>1.80</u>
E	Inside Corner & Base	1-3/4"	43-174	2.25	<u>1.99</u>
F	Outside Corner & Base	3/4"	43-755	1.95	<u>1.60</u>
F	Outside Corner & Base	1-1/4"	43-115	2.15	<u>1.80</u>
F	Outside Corner & Base	1-3/4"	43-175	2.25	<u>1.99</u>
G	Tee Adapter & Base	3/4"	43-756	2.25	<u>1.99</u>
G	Tee Adapter & Base	1-1/4"	43-116	2.15	<u>1.80</u>
G	Tee Adapter & Base	1-3/4"	43-176	2.25	<u>1.99</u>
H	Joint Cover	3/4"	43-751	1.60	<u>1.20</u>
H	Joint Cover	1-1/4"	43-111	1.95	<u>1.60</u>
H	Joint Cover	1-3/4"	43-171	1.95	<u>1.60</u>
I	End Cap	3/4"	43-752	1.60	<u>1.20</u>
I	End Cap	1-1/4"	43-112	1.60	<u>1.20</u>
I	End Cap	1-3/4"	43-172	1.95	<u>1.60</u>
J	Adapter 1-3/4" to 3/4"	--	43-767	1.50	<u>1.28</u>
J	Adapter 1-1/4" to 3/4"	--	43-769	1.60	<u>1.20</u>
J	Adapter 1-3/4" to 1-1/4"	--	43-761	2.15	<u>1.88</u>
K	Ceiling Entry	3/4"	43-759	1.60	<u>1.60</u>
K	Ceiling Entry	1-1/4"	43-119	1.95	<u>1.72</u>
K	Ceiling Entry	1-3/4"	43-179	2.68	<u>2.38</u>
L	Wall Entry	3/4"	43-758	4.40	<u>3.90</u>
L	Wall Entry	1-1/4"	43-118	4.40	<u>3.90</u>
L	Wall Entry	1-3/4"	43-178	4.40	<u>3.90</u>
M	Single Gang Surface Box	--	42-115	3.96	<u>3.75</u>
M	Double Gang Surface Box	--	42-117	4.70	<u>4.45</u>

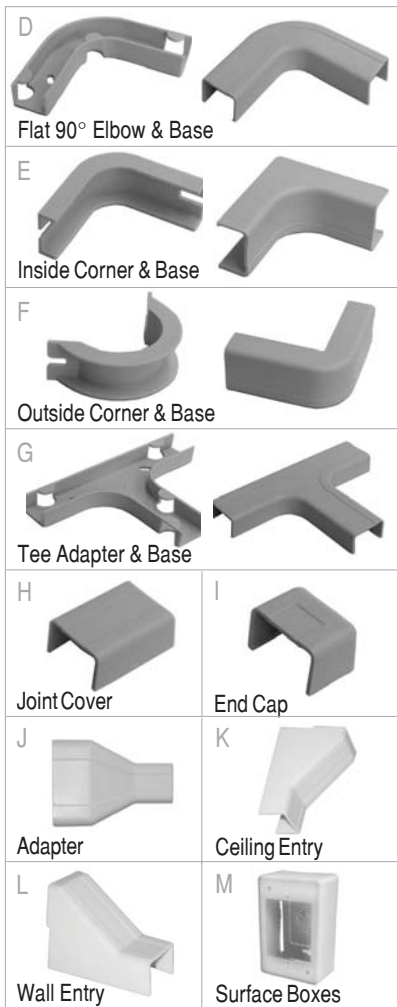

The one piece design construction of 94V-O rigid vinyl, features a highly flexible hinge and self-locking latch. Office White.

PVC Raceway Cutter

Ratchet design - Easy on hands. Removable adaptor for flat wiring duct. Cuts up to 1.25" diameter PVC pipe.
84-808



19.90

Cable Ties

100 per package.

CNA#		1-4	5+
A 89-860	4"	1.25	<u>.99</u>
A 89-880	8"	2.45	<u>1.95</u>
A 89-890	15"	6.10	<u>5.95</u>
B 89-895	1/2" Sq.	7.90	<u>7.40</u>

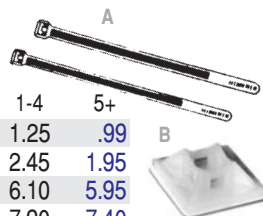

800-516-1262

www.FastComputerParts.com



Solder Type

Gold Plated
Contacts



CNA#		1-24	25+
85-009	DB-9, Male	.30	.24
85-109	DB-9, Female	.30	.24
85-015	DB-15, Male	.35	.28
85-115	DB-15, Female	.37	.30
85-020	DB-15, Male(HD)	.55	.40
85-120	DB-15, Female(HD)	.55	.40
85-025	DB-25, Male	.37	.30
85-125	DB-25, Female	.40	.32

D-Sub Wall Plates

Flush Mount,
Stainless-Steel



CNA#		1-24	25+
85-251	9C Single	1.90	1.60
85-252	9C Dual	1.90	1.60
85-261	15C Single	1.90	1.60
85-262	15C Dual	1.90	1.60
85-271	25C Single	1.90	1.60
85-272	25C Dual	1.90	1.60

IDS Socket Connectors

For Flat Cable



CNA#		1-24	25+
85-520	20 Pin IDC	.33	.26
85-534	34 Pin IDC	.37	.30
85-540	40 Pin IDC	.43	.35
85-550	50 Pin IDC	.55	.44

Hoods

		1-24	25+
85-409	9C Gray Plastic - Cable-Clamp Strain Relief	.30	.24
85-411	9C Metalized Plastic - Cable-Clamp Strain Relief	.45	.36
85-415	15C Gray Plastic - Cable-Clamp Strain Relief	.30	.24
85-417	15C Metalized Plastic - Cable-Clamp Strain Relief	.58	.46
85-425	25C Gray Plastic - Cable-Clamp Strain Relief	.33	.26
85-427	25C Metalized Plastic - Cable-Clamp Strain Relief	.50	.40
85-410	9C Gray Plastic - Side-Screw Strain Relief	.53	.42
85-412	9C Metalized Plastic - Side-Screw Strain Relief	.80	.64
85-426	25C Gray Plastic - Side-Screw Strain Relief	.65	.52
85-428	25C Metalized Plastic - Side-Screw Strain Relief	.90	.72
85-450	9C Metal - Diecast Metal	1.53	1.22
85-453	15C Metal - Diecast Metal	2.20	1.76
85-455	25C Metal - Diecast Metal	2.20	1.76

Crimp Type

Tin Plated Housing,
Requires pins



CNA#		1-24	25+
85-010	DB-9, Male	.30	.24
85-110	DB-9, Female	.30	.24
85-016	DB-15, Male	.45	.39
85-118	DB-15, Female	.45	.39
85-022	DB-15, Male(SVGA)	.67	.59
85-122	DB-15, Female(SVGA)	.67	.59
85-027	DB-25, Male	.30	.24
85-127	DB-25, Female	.33	.26

Crimp Pins (Package of 100)

Gold Plated

Contacts



CNA#		1-4	5+
85-055	Male	4.50	3.90
85-155	Female	4.50	3.90
85-057	Male (SVGA)	4.50	3.90
85-157	Female (SVGA)	4.50	3.90

D-Sub Installation Tools

CNA#		1-4	5+
85-212	D-Sub and Butt connectors.	8.90	8.13
85-200	Insertion/Extraction Tool	2.25	1.93

Flat Ribbon Cable, 100' Roll

AWG 28 Insulated Displacement Cable,
Gray PVC Jacket, Red Polarizing



Stripe 0.050" Center-to-Center

CNA#		1-4	5+
85-040	40-Conductor	23.50	21.75
85-050	50-Conductor	44.75	42.75
85-068	68-Conductor SCSI-III	99.00	95.00

**QUANTITY
PRICING
AVAILABLE**



Visit us on the web for our complete product line

www.FastComputerParts.com

800-516-1262

18 Fax: 800-236-5672

Modular Phone Plugs

100 per pkg



CNA#		1-4	5+
83-064	4C 6x4 RJ11 Flat Wire	4.95	3.95
83-066	6C 6x6 RJ12 Flat Wire	4.95	3.95
83-068	8C 8x8 RJ45 Flat Wire	11.95	10.95

Flat Modular Cable, 1000' Roll

Silver PVC

83-840	4-Conductor	46.45
83-860	6-Conductor	64.25
83-880	8-Conductor	76.40



Modular Crimping Tool

Hardened steel frame with black-oxide finish. Separate cutting and stripping blades.



83-119	RJ11/12	7.90
83-509	RJ45	6.80

Flat Wire Modular Cables

Reverse wired for voice/telephone applications.

CNA#		1-9	10+
83-536	14' RJ11 - Reverse	.90	.78
83-538	25' RJ11 - Reverse	1.10	.98
83-540	50' RJ11 - Reverse	3.52	3.20
83-542	100' RJ11 - Reverse	3.75	3.35
83-545	14' RJ12 - Reverse	1.50	1.25
83-554	14' RJ45 - Reverse	2.52	2.20



Straight wired for data applications.

83-537	14' RJ11 - Straight	.90	.78
83-544	25' RJ11 - Straight	2.10	1.98
83-547	50' RJ11 - Straight	3.52	3.20
83-549	100' RJ11 - Straight	6.75	6.35
83-546	14' RJ12 - Straight	1.50	1.25
83-555	14' RJ45 - Straight	2.52	2.20

B-Wire Crimp Connectors (25 Pak)

Insulated butt connector.

Great for telephone applications.

CNA#	1-9	10+
89-879	2.25	1.90



3M UR2 Connectors (10 Pak)

Self-stripping, insulated and moisture resistant connector for 2 or 3-wire solid copper conductor combinations for #19-#26 AWG. 10 per package.

CNA#	1-9	10+
89-875	2.25	1.90



Modular Couplers



CNA#		1-9	10+
83-020	RJ11/12, Reverse wired	.55	.39
83-025	RJ45, Reverse wired	.60	.45
83-037	6C/RJ11/12, Straight wired	.47	.36
83-039	8C/RJ45, Straight wired	.59	.46

Modular Phone Tee



CNA#		1-9	10+
83-070	RJ11/12, 1 Plug / 2 Jacks	.79	.59
83-074	RJ11/12, 1 Jack / 2 Jacks	.79	.59

Two Line Tap

Taps two line phone jacks into Line 1, Line 2 and Line 1 + 2.



CNA#		1-9	10+
83-530	RJ11/12	1.65	1.25

Modular Surface Jacks

CNA#		1-9	10+
83-145	4C 6x4 RJ11	.58	.45
83-147	6C 6x6 RJ12	.69	.56
83-149	8C 8x8 RJ45	.85	.68



Modular Wall Jacks

CNA#		1-9	10+
83-041	4C/RJ11	.68	.52
83-061	6C/RJ12	.78	.62
83-081	8C/RJ45	.82	.68



66 Block Accessories



CNA#		1-4	5+
83-665	66 - No Telco/25 Pairs	12.50	11.50
83-662	66 - 2 Telco Female/25 Pairs	42.00	39.00
83-669	66 - 89B Bracket	2.60	2.25
83-660	66 - 89D Bracket	2.60	2.25
83-664	66 - Bridge Clips, 50pcs	5.90	5.50



F Connector with 1/4" Ring



CNA#		1-99	100+
72-010	F59 RG59 Nickel	.13	.10
72-015	F56 RG6 Nickel	.13	.10

F Connector with Attached Ring



CNA#		1-99	100+
72-020	F59 RG59 Nickel	.14	.11
72-025	F56 RG6 Nickel	.22	.18

F Connector with 1/2" Barrel



CNA#		1-99	100+
72-030	F59 RG59 Nickel	.34	.28
72-031	F59 RG59 Gold	.42	.38
72-035	F56 RG6 Nickel	.34	.28
72-036	F56 RG6 Gold	.38	.34

Twist-On F Connector



CNA#		1-99	100+
72-040	F59 RG59 Nickel	.14	.11
72-039	F56 RG6 Nickel	.17	.14

F Connector with Weather O-Ring Barrel



Anti-Corrosion
Chrome Plating

CNA#		1-99	100+
72-024	F56 RG6	.44	.39
72-023	F56 RG6 Weatherproof	.37	.32

F Terminator

75 Ohms - 5% 1/2W



CNA#		1-24	25+
72-075	F Plug	.37	.28

F Plug Coupler



CNA#		1-24	25+
72-100	F Plug to F Plug	.80	.70

F Couplers

CNA#		1-24	25+
72-050	Nickel	.16	.12
72-051	Gold	.46	.39
72-053	Nickel with Nut & Washer	.17	.13



F-Quick Plugs



CNA#		1-24	25+
72-103	Nickel	.35	.30
72-104	Gold	.69	.59

RCA to F Adapters



CNA#		1-24	25+
72-045	RCA Jack to F Plug	.69	.59
72-110	RCA Plug to F Jack	.62	.52

BNC to F Adapters



CNA#		1-24	25+
72-108A	BNC Jack to F Plug	1.02	.92
72-130	BNC Plug to F Jack	.98	.86

BNC to RCA Adapter



CNA#		1-24	25+
72-170	BNC Jack to RCA Male	.75	.66

F to 3.5 Mono Plug



CNA#		1-24	25+
72-117	F Jack to 3.5 Male Plug	.75	.66

F Panel Jack



CNA#		1-24	25+
72-055	Nickel	.37	.30

F Angle Adapter



CNA#		1-24	25+
72-107	F Jack to F Plug	.66	.56

Visit us on the web for our complete product line

www.FastComputerParts.com

800-516-1262

20 Fax: 800-236-5672

Audio Adapters

	(A)	(B)	(C)	(D)		
CNA#					1-24	25+
88-101	(A) RCA Coupler Plug to Plug				.30	.25
88-116	(B) RCA Coupler Jack to Jack				.30	.25
88-118	(C) 3.5mm St-Jack to St-Jack				.90	.70
88-123	(D) RCA Jack to 1/4" Mn-Plug				.65	.50

	(A)	(B)	(C)	(D)		
CNA#					1-24	25+
88-124	(A) RCA Jack to 3.5mm Mn-Plug				.40	.30
88-126	(B) 3.5mm Mn-Jack to 2.5 Mn-Plug				.59	.46
88-131	(C) 2x3.5mm St-Jacks to 3.5 St-Plug				.95	.75
88-140	(D) 2 x1/4" St-Jacks to 3.5 St-Plug				1.30	1.10

	(A)	(B)	(C)	(D)		
CNA#					1-24	25+
88-142	(A) 2x3.5 St-Jacks to 1/4" St-Plug				1.00	.90
88-145	(B) 3.5mm Mn-Jack to 1.3mm Plug				1.00	.90
88-148	(C) 3.5mm Mn-Jack to 3.0mm Plug				1.00	.90
88-149	(D) 1/4" Mn-Jack to RCA Plug				.90	.80

	(A)	(B)	(C)	(D)		
CNA#					1-24	25+
88-151	(A) 3.5mm Mn-Jack to RCA Plug				.55	.48
88-154	(B) 1/4" St-Jack to 3.5mm St-Plug				.49	.42
88-156	(C) 3.5mm Mn-Jack to 1/4" Mn-Plug				.42	.36
88-158	(D) 3.5mm Mn-Jack to 1/4" St-Plug				.53	.46

	(A)	(B)	(C)	(D)		
CNA#					1-24	25+
88-159	(A) 3.5mm ST-Jack to 1/4" St-Plug				.47	.39
88-164	(B) 3.5mm ST-Jack to 3.5 Mn-Plug				.40	.34
88-171	(C) 1/4" St-Jack to 3.5mm Mn-Plug				.49	.42
88-175	(D) 1/4" Mn-Plug to 3.5mm Mn-Plug				.42	.36

S-VHS Video Cables

4-Contact Gold Mini Din
Black PVC Jacket

CNA#		1-9	10+
88-207	6' Mini Din to Mini Din	1.90	1.60
88-210	12' Mini Din to Mini Din	2.60	2.20
220204	25' Mini Din to Mini Din	3.64	3.24
88-209	50' Mini Din to Mini Din	8.50	7.90
202206	100' Mini Din to Mini Din	14.16	13.25
88-212	6' Mini Din to 2xRCA Jacks	2.90	2.50
88-213	12' Mini Din to 2xRCA Jacks	3.70	3.20

6" RCA Y-Cable Adapters

Shielded Y-Cables
Black PVC Jacket
Color Coded

CNA#		1-9	10+
88-008	1-Male RCA to 2-Females RCA	.69	.49
88-018	1-Male RCA to 2-Males RCA	.69	.49
88-019	1-Female RCA to 2-Males RCA	.69	.49

3.5mm Y-Cable Adapters

3.5mm Stereo to Stereo
Black PVC Jacket
Color Coded

CNA#		1-9	10+
88-583	6" 1-Male to 2-Females	1.25	.99
88-043	6" 1-Male to 2-Females	2.25	1.92
88-046	6" 1-Female to 2-Males	1.25	.99

Y-Cable Adapter

Two RCA Plugs to
3.5mm (1/8") Stereo-Plug.

CNA#		1-4	5+
88-047	6" Stereo	.79	.59
88-589	6" Stereo	1.25	.99

6" Y-Cable Adapter

Two RCA Jacks to
3.5mm (1/8") Plug.

CNA#		1-4	5+
88-044	Stereo	.69	.49

Visit us at
www.FastComputerParts.com
for our full line of Audio/Video Cables

Stereo Audio Patch Cord

3.5mm (1/8") Stereo-Plug to
Stereo-Plug.

CNA#		1-4	5+
88-581	2'	1.05	.79
88-585	6'	1.25	.99
88-262	12'	1.55	1.25
88-264	25'	2.10	1.80

Stereo Extension Cord

3.5mm (1/8") Stereo-Plug to
Stereo-Jack.

CNA#		1-4	5+
88-587	6'	1.25	.99
88-268	12'	1.95	1.65
88-269	25'	2.20	1.70



Cable Siding Clips

100 Per Pack (A)



CNA#		1-4	5+
72-951BK (A)	RG59 Black Horizontal	4.50	3.90
72-951CL (A)	RG59 Clear Horizontal	4.50	3.90
72-952BK (A)	RG6 Black Horizontal	8.10	7.50
72-952CL (A)	RG6 Clear Horizontal	8.10	7.50
72-953BK (B)	RG59 Black Vertical	7.50	6.90
72-953CL (B)	RG59 Clear Vertical	7.50	6.90
72-954BK (B)	RG6 Black Vertical	13.25	12.50
72-954CL (B)	RG6 Clear Vertical	13.25	12.50

Cable Clips

100 Per Pack



CNA#		1-4	5+
82-955 (A)	RG59 Black	2.55	2.04
72-956 (A)	RG59 White	2.65	2.10
72-960 (A)	RG6 Black	3.45	2.95
72-962 (B)	RG6 Dual Black	4.60	4.10
72-505 (C)	1/4" Clear UL94V2	4.10	3.60
72-511 (C)	3/8" Clear UL94V2	6.50	5.90
72-515 (C)	1/2" Clear UL94V2	7.60	6.90

Cable Feed-Throughs

25 Per Pack (A)



CNA#		1-4	5+
72-982BK (A)	RG59 Black	1.90	1.50
72-986BK (A)	RG6 Black	1.90	1.50
72-986IV (A)	RG6 Natural Ivory	1.90	1.50
72-988BK (B)	RG6 Dual Black	2.65	2.20
72-988IV (B)	RG6 Dual Natural Ivory	2.65	2.20

Grounding Post/Straps/Wire



CNA#		1-4	5+
72-912 (A)	10" Strap - 1/2" to 2" Pipe	1.25	.99
72-902 (B)	25' AWG8 Aluminum Wire	3.50	2.95
72-290 (C)	4' Grounding Post	3.75	3.25

Satellite-Dish Level or Direction Compass

CNA#		
72-990	Compass	.59
72-991	2-Level	1.50



Matching Transformers

75/300 Ohm
5-900 MHz UHF/VHF/FM



CNA#		1-24	25+
72-500	Indoor Nickel	.42	.36

Matching Transformer

75/300 Ohm
5-900 MHz
UHF/VHF/FM



CNA#		1-24	25+
72-510	Indoor Nickel	.31	.25

Weather Boot

F Weather Rubber Seal Slips over F jacks to cover and protect connection joint.



CNA#		1-24	25+
72-978	3/8" Diameter Black	.19	.15

Security Shields

1-1/8" Die Cast Metal Shields. Used to protect F Connectors from unwanted tampering.



CNA#		1-24	25+
72-966	Screw-On	.43	.38
72-968	Slip-On	.40	.34

Security Shields Tool

Nickel Plated Brass Construction.



CNA#		
72-961		2.50

Broadband Amplifier

54-890MHz UHF/VHF/FM
AC Powered
Indoor use only.



CNA#		1-4	5+
72-656	10dB UL Approved	10.60	9.90
72-651	25dB UL Approved	16.75	15.75

Satellite Finder Meters

Highly Sensitive Meters with Built-In-Buzzer. 75 Ohm
950-2050 MHz.



CNA#		
72-993	LED Bar	21.50
72-992	Analog	15.75

Visit us on the web for our complete product line

www.FastComputerParts.com

800-516-1262

22 Fax: 800-236-5672

F Couplers



CNA#		1-24	25+
72-050	Nickel 900MHz	.16	.12
72-057	Nickel 1GHz	.69	.59
72-058	Nickel 2GHz	.79	.69

2GHz Splitters

5-2050MHz 75-Ohm DSS
Ready Satellite Splitters.
90db min RF Shielding and
Anti-Corrosion Plating.



CNA#		1-9	10+
72-232	2-Way 2GHz, 1-DC Port	1.90	1.60
72-242	2-Way 2GHz, DC Pass	1.99	1.69
72-234	4-Way 2GHz, 1-DC Port	3.98	3.48
72-244	4-Way 2GHz, DC Pass	4.10	3.64

Grounding Blocks

3/16" Grounding Hole
accepts AWG8 Wire.



CNA#		1-9	10+
72-271	Single - 900MHz	.45	.38
72-272	Dual - 900MHz	.90	.80
72-274	Single - 1GHz	.56	.46
72-275	Dual - 1GHz	.96	.84
72-278	Single - 2GHz	.75	.62
72-279	Dual - 2GHz	1.10	.92

900MHz Splitters

5-900MHz 75-Ohm MATV
Low-Cost DC Power Passing
Splitters. Epoxy Sealed with
Anti-Corrosion Plating.



CNA#		1-9	10+
72-222	2-Way 900MHz	.86	.76
72-223	3-Way 900MHz	1.09	.99
72-224	4-Way 900MHz	1.38	1.26
72-206	6-Way 900MHz	3.75	3.26
72-208	8-Way 900MHz	4.20	3.64

1GHz Splitters

5-1000MHz 75-Ohm Digital-Cable
Ready CATV Splitters. Suitable
for Hybrid Distribution
Networks, Voice-Data, and
Modem Applications. Fully Water
Resistant and All Ports DC Blocked.



CNA#		1-9	10+
72-102	2-Way 1GHz, 130dB	3.60	3.36
72-101	3-Way 1GHz, 130dB	3.98	3.70
72-105	4-Way 1GHz, 130dB	4.40	4.10
72-106	6-Way 1GHz, 130dB	8.25	7.58
72-112	8-Way 1GHz, 130dB	8.90	8.25

FastComputerParts.com

Ratchet Type Cable Crimping Tool

9" Hex crimp tool for RG58, RG59, RG62
and RG6 fittings and center pin.
Full cycle ratchet mechanism.

72-005



24.75

Economy Cable Crimping Tool

8" Oval Crimp Tool for
RG59, RG62 and RG6.

72-009



5.90

Cable Crimping Tool

9" Hex Crimp Tool for RG59,
RG62 and RG6 and Center
Pin. High Lever Action.

72-007



19.50

Coaxial Stripping Tool

Rotary Coaxial Cable Stripper for
RG6, RG58, and RG59
Requires No Blade Adjustment.

72-001



9.90

F-Quick Coaxial Cables

75-Ohm Low-loss RG59/U
Fully Molded Cables. Nickel
Plated F Connector.



CNA#		1-9	10+
72-111	3' Black - Nickel	.90	.70
72-115	6' Black - Nickel	1.20	.96

Bulk Coaxial Cable 1000' Rolls - 75 Ohm



CNA#		67.50	97.40	128.75	119.50
72-910	RG59/U Black				
72-930	RG6/U Black				
72-934	RG6/U Black w/Messenger				
72-935	RG6/U Black PVC Quad Shield				

800-516-1262

www.FastComputerParts.com



F Coaxial Cables

75-Ohm Low-loss RG59/U
Fully Molded Cables. Nickel
Plated F Connector.



CNA#		1-9	10+
72-011	3' Black - Nickel	.66	.56
72-210	3' Black - Gold	1.65	1.40
72-012	3' White - Nickel	.66	.56
72-016	6' Black - Nickel	.95	.80
72-215	6' Black - Gold	1.65	1.40
72-017	6' White - Nickel	.95	.80
72-021	12' Black - Nickel	1.62	1.32
72-022	12' White - Nickel	1.62	1.32
72-032	25' Black - Nickel	2.75	2.22
72-033	25' White - Nickel	2.75	2.22
72-034	50' Black - Nickel	4.50	3.92
72-037	50' White - Nickel	4.50	3.92
72-038	100' Black - Nickel	8.60	7.62
72-041	100' White - Nickel	8.60	7.62

High Grade F Coaxial Cables

75-Ohm Low-loss RG6/U UL
Suitable for Digital Cable, DSS
C/KU Satellite Installations.



CNA#		1-9	10+
72-410	3' Black - Nickel	1.25	.99
72-411	3' White - Nickel	1.25	.99
72-415	6' Black - Nickel	1.85	1.42
72-416	6' White - Nickel	1.85	1.42
72-420	12' Black - Nickel	2.90	2.30
72-421	12' White - Nickel	2.90	2.30
72-430	25' Black - Nickel	4.80	4.00
72-431	25' White - Nickel	4.80	4.00
72-435	50' Black - Nickel	7.99	6.99
72-436	50' White - Nickel	7.99	6.99
72-445	100' Black - Nickel	14.50	13.30
72-446	100' White - Nickel	14.50	13.30

High Performance 5 RCA Component Video Cables



CNA#		1-9	10+
72-903	3' Black - 5 RCA	7.90	7.25
72-931	6' Black - 5 RCA	12.40	11.75
72-932	12' Black - 5 RCA	19.90	18.90
72-915	25' Black - 5 RCA	34.90	32.90
72-949	50' Black - 5 RCA	54.20	52.20
72-945	75' Black - 5 RCA	89.00	86.00
72-936	100' Black - 5 RCA	99.50	96.50

HDMI Cables

1080P Compatible



CNA#		1-4	5+
72-772	3' (1M) HDMI Male to Male	3.50	2.90
72-776	6' (2M) HDMI Male to Male	5.60	4.90
72-771	9' (3M) HDMI Male to Male	8.80	7.90
72-770	16' (5M) HDMI Male to Male	9.90	9.00
181205	22' (7M) HDMI Male to Male	10.50	9.50
181206	30' (10M) HDMI Male/Male	12.90	11.90
181207	50' (16M) HDMI Male/Male	75.00	72.50
181208	75' (25M) HDMI Male/Male	82.00	79.00
181209	100' (30M) HDMI Male/Male	129.50	125.00
181210	150' (50M) HDMI Male/Male	144.50	139.00
72-775	3' (1M) HDMI Male to DVI	7.50	6.90
72-779	6' (2M) HDMI Male to DVI	9.90	9.20
72-774	9' (3M) HDMI Male to DVI	10.90	10.20
72-781	16' (5M) HDMI Male to DVI	15.75	14.25
181215	22' (7M) HDMI Male to DVI	21.50	20.00
181216	30' (10M) HDMI Male to DVI	24.50	23.00

HDMI Adapters



CNA#		1-4	5+
181240	HDMI Male to DVI Female	6.50	5.90
181241	HDMI Female to DVI Male	6.50	5.90
181242	HDMI Female to Female	5.90	5.50

HDMI Switches w/Remote

The HDMI Switcher allows
access to multiple HDMI devices.



110301	2 Way Switch	59.00
110303	4 Way Switch	79.00

High Performance 3 RCA Component Video Cables



CNA#		1-9	10+
72-920	3' Black - 3 RCA	5.90	5.40
72-906	6' Black - 3 RCA	8.90	8.40
72-922	12' Black - 3 RCA	12.40	11.75
72-925	25' Black - 3 RCA	16.90	15.90
72-950	50' Black - 3 RCA	33.00	31.75
72-975	75' Black - 3 RCA	39.90	37.90
72-940	100' Black - 3 RCA	49.90	47.75

Visit us on the web for our complete product line

www.FastComputerParts.com

800-516-1262

24 Fax: 800-236-5672

Economy Video Patch Cables

Low-Loss VCR Dubbing Cables.
RCA to RCA Color Coded



CNA#		1-9	10+
72-276	6' Stereo 1-Video, 2-Audio	1.95	1.70
72-273	12' Stereo 1-Video, 2-Audio	3.25	2.80

Gold Video Patch Cables

Low-Loss VCR Dubbing
Cables. RCA to RCA
RG59 Video - Color Coded



CNA#		1-9	10+
72-250	6' Mono 1-Video, 1-Audio	2.20	1.80
72-263	12' Mono 1-Video, 1-Audio	3.30	2.90
72-277	3' Stereo 1-Video, 2-Audio	3.90	3.60
72-280	6' Stereo 1-Video, 2-Audio	3.90	3.60
72-281	12' Stereo 1-Video, 2-Audio	4.10	3.60
72-282	18' Stereo 1-Video, 2-Audio	5.50	4.90
72-284	25' Stereo 1-Video, 2-Audio	6.50	5.90

Premium Video Cables

High-Grade VCR Dubbing
Cables. RCA to RCA
Color Coded



CNA#		1-9	10+
72-261	6' Mono 1-Video, 1-Audio	6.30	5.90
72-269	12' Mono 1-Video, 1-Audio	7.40	6.90
72-265	6' Stereo 1-Video, 2-Audio	8.50	7.90

Python Home Theater Patch Cables

High-Definition Interconnect
Cables. Gold RCA to RCA
100% Copper Shield



CNA#		1-9	10+
72-108C	3' 1-RCA to 1-RCA	1.80	1.50
72-116	6' 1-RCA to 1-RCA	2.40	2.10
72-122	12' 1-RCA to 1-RCA	3.40	2.90
72-211	3' 2-RCA to 2-RCA	3.40	2.90
72-216	6' 2-RCA to 2-RCA	4.30	3.90
72-219	12' 2-RCA to 2-RCA	6.40	5.90
72-311	3' 3-RCA to 3-RCA	4.40	3.90
72-316	6' 3-RCA to 3-RCA	5.90	5.40
72-319	12' 3-RCA to 3-RCA	8.50	7.90

Optical Digital-AV Adapters



CNA#		1-9	10+
88-700	Toslink to Toslink Coupler	4.25	3.80
88-710	Toslink to Mini-Plug	4.25	3.80

Audio RCA Patch Cables

Shielded Patch Cords
RCA to RCA



CNA#		1-9	10+
88-112	6' Mono 1-Audio	1.10	.85
88-113	10' Mono 1-Audio	1.10	.85

Audio RCA Patch Cables

Shielded Patch Cords
2-RCA to 2-RCA
Color Red and White



CNA#		1-9	10+
88-122	3' Stereo 2-Audio	.99	.79
88-125	6' Stereo 2-Audio	1.25	.99
88-129	12' Stereo 2-Audio	1.75	1.49
88-135	25' Stereo 2-Audio	2.40	2.10

www.FastComputerParts.com

Premium Audio RCA Patch Cables

Low-Loss 95% Shield
2-RCA to 2-RCA Fully Molded
Color Coded Red and White



CNA#		1-9	10+
88-220	3' Stereo 2-Audio	1.95	1.60
88-225	6' Stereo 2-Audio	2.30	1.90
88-230	12' Stereo 2-Audio	2.90	2.50
88-240	25' Stereo 2-Audio	4.50	3.90

Optical Digital-Audio Cables

High-Purity Fiber Toslink
Cables. Suitable for CD,
MiniDisc, DVD and MP3
Applications. Convex
Optical Lens for Optimum
Performance.



CNA#		1-9	10+
88-003	3' Toslink to Toslink	3.40	2.90
88-006	6' Toslink to Toslink	4.20	3.70
88-012	12' Toslink to Toslink	6.40	5.90
88-103	3' Toslink to Mini-Plug	7.40	6.90
88-106	6' Toslink to Mini-Plug	9.50	8.90
88-114	12' Toslink to Mini-Plug	14.80	13.90
88-203	3' Mini-Plug to Mini-Plug	7.40	6.90
88-206	6' Mini-Plug to Mini-Plug	9.50	8.90
88-214	12' Mini-Plug to Mini-Plug	14.80	13.90



Professional PCI DVR Cards

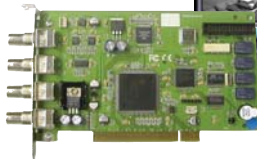

A DVR replaces the old TV Monitors, Video Quads and Time Lapse Recorders with high performance digital surveillance and recording. These PC based surveillance cards are great for personal and business applications. Pro DVR is the perfect loss prevention solution for all types of businesses including restaurants, bars, retail shops, daycare, convenience stores and homes. The software includes the remote networking and alarm monitoring software.

High Quality:

Pro DVR provides high quality recording of all cameras with quick and clear playback. The video clips can be printed and/or stored on floppy or CD's, and played back on any PC with Windows Media Player.

Saves Time:

Pro DVR allows you to store weeks of video on one 80 GIG hard drive and allows you to review your recordings quick and effectively. No more changing VCR tapes everyday or hours spent searching through VCR tapes to find an incident.

CNA#

10-844	4	Camera DVR Card, 30 FPS	159.00
10-853	4	Camera DVR Card, 60 FPS	295.00
10-868	4	Camera DVR Card, 120 FPS	430.00
10-876	8	Camera DVR Card, 60 FPS	340.00
10-845	8	Camera DVR Card, 120 FPS	520.00
10-816	16	Camera DVR Card, 60 FPS	459.00
10-849	16	Camera DVR Card, 120 FPS	659.00
10-855	16	Camera DVR Card, 240 FPS	850.00

Economy DVR Cards



4 channel video and 1 channel audio 60fps DVR card. Complete with software, drivers and installation instructions. Easy to install in most desktop computers, this DVR card can be expanded for use with up to 32 cameras.

CNA#			Each
10-835	4	Camera DVR PCI Card	59.00
10-829	4	Camera USB DVR	109.00

Color Dome Cameras

3.6mm Lens
12V DC Power



CNA#			Each
10-942	1/4"	Sharp, 420 Line, 0.5 Lux	39.00
10-931	1/3"	Sony, 420 Line, 0.5 Lux	59.50
10-922	1/3"	Sony, 530 Line, 0.5 Lux	129.00

Waterproof Bullet Cameras

1/3" CCD, 380 Lines, 92°
12VDC +/- 10%, 75 Ohms



10-020	B/W	79.25
10-380	B/W IR	85.75
10-301	Color	98.50

Infrared Cameras

3.6mm Color Lens
0 Lux, 12V DC Power
Weatherproof housing.



CNA#			Each
10-940	1/4"	Sony, 420 Line, 151R 30 Feet	59.00
10-935	1/4"	Sony, 420 Line, 301R 50 Feet	79.50
10-945	1/3"	Sony, 420 Line, 301R 50 Feet	89.00

Infrared Dome Cameras

3.6mm Color Lens
0 Lux, 12V DC Power



CNA#			Each
IR9524	1/3"	Sony, 420 Line, 241R 40 Feet	89.00
IR9524H	1/3"	Sony, 540 Line, 241R 40 Feet	129.00

Color Outdoor Camera

All in one security camera with waterproof housing. 40 IR LEDs for great night vision. 1/3" CCD Image Sensor. 380 Lines, 0.0 Lux, 12VDC, 75 Ohms.



10-540	Color	185.00
--------	-------	--------

Rotating Dummy Camera

Rotating dummy camera with LED and motorized pan movement imitates real security camera. Requires (3) AA batteries (not included).



10-121	With LEDs	9.75
--------	-----------	------

Visit us on the web for our complete product line

www.FastComputerParts.com

800-516-1262

26 Fax: 800-236-5672

Standard CS Color Cameras

Sony Super HAD,
12V DC Power
Lens not included.



CNA#		Each
10-941	1/4" Sony, 420 Line, F1.4, .5 Lux	49.00
BO6440	1/3" Sony, 420 Line, F1.4, .5 Lux	69.00
BO6350	1/3" Sony, 530 Line, F1.4, .5 Lux	109.00

Standard Color Cameras Day or Night w/Varifocal Lens

1/3" Sony Super HAD
537(H) x 505(W), NTSC
12VDC Power



CNA#		Each
500416	420 Lines, 3.8-9.5mm, 0.45 LUX/F1.2	179.00

Cameras Lenses CS Mount Fixed



CNA#		Each
500506	3.6mm, Fixed Iris F1.4 1/3"	14.90
500507	6mm, Fixed Iris F1.4 1/3"	14.90
500508	8mm, Fixed Iris F1.4 1/3"	14.90
500509	12mm, Fixed Iris F1.4 1/3"	17.90
500510	16mm, Fixed Iris F1.4 1/3"	17.90
500511	25mm, Fixed Iris F1.4 1/3"	24.90

Cameras Lenses CS Mount Vari-Focal Auto Iris



CNA#		Each
500519	2.8~12mm, Vari-Focal, F1.4 1/3"	65.00
500520	3.5~8mm, Vari-Focal, F1.4 1/3"	45.00
500521	6~15mm, Vari-Focal, F1.4 1/3"	55.00
500522	6~60mm, Vari-Focal, F1.4 1/3"	79.00
500523	5~100mm, Vari-Focal, F1.4 1/3"	89.00

Stand Alone Infrared Illuminator

Easy installation
Includes 12VDC Power
Weatherproof housing.



CNA#		Each
10-075	850nm IR, 100' Range	59.00
10-080	850nm IR, 225' Range	89.00

Camera Power Supplies

UL Listed Transformers.
Continuous current with
individual outputs.
5 second auto reset.



CNA#		
10-645	DC12V, 9 Port, 5A	65.75
500912	DC12V, 18 Port, 10A	89.75
500913	DC12V 9P/AC24V 9P Combo, 10A	99.75

12VDC Power Adapters

12VDC UL AC-DC Adapter.
2.1MM coax, tip positive plug.



88-676	300 mA	4.75
88-681	500 mA	5.50
88-672	1000 mA	12.50
500916	1250 mA	13.50
500917	1500 mA	15.50

Power Adapters Cables

Great for adapting bulk cable to
coaxial plug for camera power.



CNA#		1-9	10+
10-015	Male Plug with 36" leads	1.50	1.25
10-018	Male Plug with Block 6" lead	2.50	2.25
500906	Female Plug with Block 6" lead	2.50	2.25

www.FastComputerParts.com

Outdoor Camera Enclosures

Heavy duty outdoor aluminum
weatherproof camera enclosures.
(Camera sold separately)



CNA#		
10-530	Enclosure Only	39.75
10-520	w/Heater and Blower	69.50

Network IP Camera

Wireless SOHO Internet Camera
ENVCWI-G features a standalone
system, which means a camera
and a computer combined in a
small package. Built-in capture
module and web server provide
users to view images and record video through IP
network (e.g. LAN and WAN) with a browser on any
computer connected to network. And it can be installed
easily and friendly by using a IP configuration software to
assign an IP to your IP camera.



ENVCWI-G	Wireless 802.11G or Wired	159.00
----------	---------------------------	--------

800-516-1262

www.FastComputerParts.com



Cat5 Video (BNC) and Power (2.1MM) Baluns

Set of (2) Baluns allows transmission of real-time monochrome or color video over unshielded twisted pair (UTP) cable.

CNA#

10-021	Video (BNC) and Power (2.1MM)	16.75
10-028	Video, Power and Audio (RCA)	18.75



Video and Power Balun

Run video signal and DC power over cat5e twisted pair.

CNA#

501504		39.50
--------	--	-------



Extended Length Video Balun

Run video signal up to 1800 ft. B/W and 1000 ft. color over cat5e twisted pair.

CNA#

501515		16.90
--------	--	-------



Video Baluns

Send video signal over standard twisted pair or Cat5 cables.

CNA#

85-100	BNC Male Plug to RJ11/12	5.50	4.90
85-102	BNC Male Plug to RJ45	6.50	5.90



Smoke Detector Type Camera

Sony Super HAD 420TVL 1/3" NTSC: 510 x 492, 420 TV Lines 0.1 Lux, F1.2 12VDC Powered

CNA#

500419		97.50
--------	--	-------



Remote Controlled Power Switch, AC125V 10Amp

Transmission range: 40Ft Splash guard. Ideal for turning on/off fountain remotely. Indoor/out door use and UL listed.

19.90



CCTV Extension Cables

Extends Video (BNC Male to Male) and Power (2.1MM Coax Male to Female).

503010	30'	7.68
503015	60'	13.96
503020	100'	19.90



CCTV Extension Cables

Extends Video (RCA Male to Male), Audio (RCA Male to Male) and Power (2.1MM Coax Male to Female).

10-025	25'	10.90
10-050	65'	14.50
10-100	100'	21.25
10-150	150'	28.75



Siamese Coaxial and Power Cable 500' Rolls

75 Ohm coaxial cable with a pair of 20 AWG power cable attached, 5 amp maximum.

CNA#

72-065	RG59/U with 20 AWG Power Pair	119.95
72-061	RG6/U with 20 AWG Power Pair	129.50



BNC Male 2 Piece Crimp-On

CNA#

82-138	RG6	1.00	.80
82-139	RG59/62	.85	.68



BNC Male to RCA Female

CNA#

82-173		1.80	1.60
--------	--	------	------



BNC Cables RG59 Molded 75 ohms

CNA#

82-303	3-Foot - Male to Male	2.15	1.80
82-306	6-Foot - Male to Male	2.65	2.10
82-312	12-Foot - Male to Male	3.10	2.60
82-325	25-Foot - Male to Male	4.35	3.75
82-350	50-Foot - Male to Male	6.10	5.50



Visit us on the web for our complete product line

www.FastComputerParts.com

800-516-1262

28 Fax: 800-236-5672

Security Enclosure w/Locking Door



The VCR/DVR Security Lock Box provides a secure means to house security VCR and DVR equipment. It's designed for maximum protection of video time-lapse recorders and like equipment protecting it from unauthorized access with enough space for switchers and accessories. It can be mounted on top surfaces or wall-mounted with optional wall mounting brackets. Solid steel hinged locking front door. Removable top panel pre-installed ventilation fan with 3' cord. Dual rear cable access plugs 18AWG all-steel construction. Dimensions: 9"H x 20"W x 21"D Weight: 30 lbs. Optional Mounting Bracket Set.

CNA#

10-519 Security Enclosure	169.00
10-515 Wall Mounting Bracket	28.00

Visit us at
www.FastComputerParts.com
for our full line of
Security Products

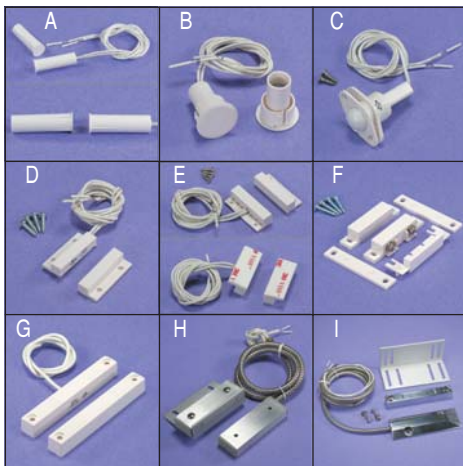

Magnet Contact Sensors, UL Approved

Description	CNA#	1-9	10up
A 3/8 x 1-1/4 Standard Recess	500103	1.90	1.70
B 3/8 x 1-1/8 Steel Recess	500105	3.60	3.30
C 2 x 1-1/2 Roller Ball	500108	2.80	2.50
D 1/3 x 1/2 x 1/4 Std Side Lead	500120	2.20	1.90
E 1/3 x 1/2 x 1/4 Std Center Lead	500121	2.20	1.90
F 2-1/2 x 3/4 x 5/8 Industry	500124	2.20	1.90
G 4-5/16 x 5/8 x 5/8 Commercial	500126	6.40	5.90
H 3 x 1/2 x 1 Metal Type	500127	13.25	12.50
I 4-5/16 x 1/2 x 1-1/2 Overhead	500128	16.25	15.50

4U Rack Mount Case w/Locking Door

Generally accepted industrial standard 19" rack-mount chassis. ATX form factor. PS/2 style power supply sold separately.

CNA#

87-643 Black, 19"(W) x 7"(H) x 18.5"(D)	149.00
---	--------



Video to VGA Converter

Convert video signal (BNC) to VGA signal. Supports NTSC, PAL and SECAM video systems.

On screen display function. Brightness, contrast, color NTSC tint control. Resolution: NTSC: 640 x 480, PAL: 768 x 576. Power supply included. BNC In - VGA Out. .

501510 BNC Female to DB15HD Female	79.00
------------------------------------	-------



Wireless Doorbell

80m range wireless doorbell with waterproof alert button. Perfect for any door.(3) AAA batteries required for operation

501901	7.90
--------	------



B-Wire Crimp Connectors (25 Pak)

Insulated butt connector.

Great for telephone applications.

CNA#	1-9	10+
89-879	2.25	1.90



3M UR2 Connectors (10 Pak)

Self-stripping, insulated and moisture resistant connector for 2 or 3-wire solid copper conductor combinations for #19-#26 AWG. 10 per package.

CNA#	1-9	10+
89-875	2.25	1.90



Numeric Label Stickers

112 Self-sticking numeric labels.

Includes: Numbers from 1~100

CNA#	1-9	10+
84-005	.45	.36

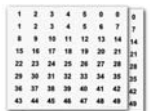

Product Label Stickers

56 Self-sticking product labels. CAT5, CATV and many more.

CNA#	1-9	10+
84-001	.45	.36

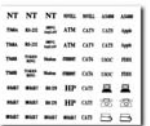



24' Fiberfish Kit

Fiberfish are 1/4" fiberglass nonconductive rods for fishing wire in existing walls and attics or across drop ceilings. Rods screw together to make longer lengths. Kit includes: (2) 6' male to female rods, (1) 6' male to male rod, (2) 3' male to female rods, (2) fish tips, and carrying case.

84-106

89.25



1/4" Fiberfish Rods & Attachments

CNA#

84-108	6' fiber rod, male-female	13.75
84-110	6' fiber rod, female-female	13.75
84-114	3' fiber rod, male-female	10.75
84-113	3' fiber rod, female-female	10.75
84-115	Directional tool	9.90
84-118	Magnet	9.90
84-119	Pull ring	3.75
84-120	Ball chain	9.75
84-121	Additional tip	2.40
84-123	Fish-hook	9.90

Steering Guide for Fish Bits and Fiberfish

This insulated steering guide helps the operator to manipulate fish bits and fiberfish while within the wall cavity.

CNA#

84-124

19.50



Fish Bits

Constructed of high carbon steel with self-feeding auger bit. Fish eye holes are provided at each end to retrieve wires from either direction after drilling.

84-140	1/4" with 54" shaft	24.75
84-141	1/2" with 54" shaft	26.25
84-142	3/4" with 54" shaft	32.50
84-143	1/4" with 72" shaft	26.75
84-144	1/2" with 72" shaft	28.25
84-145	3/4" with 72" shaft	34.75



20' Tele-Pole Wire Installation Tool



Compact 72" (4lbs) design, telescopes to 20' in seconds. Great to push/pull wires over long spans, suspended ceilings, sub-floors, crawl spaces, and attics. Made of aircraft quality aluminum with fiberglass insulated handle.

84-173

129.75

Fibersnake

Fibersnake is a 3/16" rod with fiberglass reinforced composite core jacketed in rugged plastic to ensure long life. Offered in a PVC



storage case in 25' and 40' lengths. Longer lengths comes in cage with a hand operated brake. There is a bullnose at each end, so that wires can be pulled from either directions. Great for pulls through conduit.

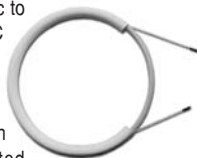

84-320	25' Fibersnake	59.00
84-322	40' Fibersnake	79.00
84-325	50' Fibersnake	182.00
84-326	100' Fibersnake	226.00
84-329	200' Fibersnake	298.00

Tone Generator & Probe

The Tone Generator & Probe can be used to verify cable continuity, identify wiring faults, determine line polarity and voltage in network and modular telephone lines.

78-035

49.00



Engineers Test Telephone

Ideal for verifying data and voice lines during network installations. Can be used for normal two-way communications and provides all the test functions normally required for standard PABX and PSTN lines.

CNA#

1-4

5+

78-025

145.50

138.95



Visit us on the web for our complete product line

www.FastComputerParts.com

800-516-1262

30 Fax: 800-236-5672

Anti-Static Wrist Strap

Hi-Comfort adjustable Wrist Strap. Ideal for working with electronic components.

CNA#	1-4	5+
78-600	4.40	3.90



Shatter-Proof Plastic Storage Cases

CNA#		1-4	5+
78-400	Contains 6~12 compartments. 10" x 4.75" x 1.5"	3.80	3.50
78-390	Up to 24 compartments. 8" x 5.25" x 1.5"	4.40	3.90
78-395	Up to 24 compartments. 11" x 7" x 1.75"	5.90	5.50



www.FastComputerParts.com

Network Cable Tester

This cable tester is designed to quickly test by auto scanning the wires continuity, miswiring and polarization of 10/100 Base-T (UTP/STP), AT&T 285A, TIA 568A/B. By using the remote terminator, you can easily test cables before or after installation.



78-110 14.50

PC Cable Tester Pro with USB

The PC Cable tester is a stand-alone test device. It is designed to test continuity, open, shorted, and cross connected wires. Test communications of: RG58, 59, 62, RJ45, DB9, DB15, DB15HD, DB25, and Cent 36.

78-109 149.50



Cable Reel

Cable Reel takes the hassle out of installing bulk cable. Allows you to pull cable conveniently and safely from a durable, yet lightweight frame. Handles multiple spools up to 26" in diameter.

84-450 89.00



Velcro Cable Manager

10 piece package with 2 each of black, red, purple, yellow, and blue.

CNA#	1-4	5+
89-888	6-1/2" x 3/4"	4.55 3.90



Velcro Cable Ties

Black, 5 pieces 6" x 3/4"

CNA#	1-4	5+
89-892		2.25 1.90



Velcro Strap 1/2" Width Black, 50pc Pack

220901	6" Length	4.90
220902	9" Length	6.75



Hook & Loop Spool

3/4" wide and 5 yards long with self-adhesive backing.

CNA#	1-4	5+
89-885	7.40	6.80

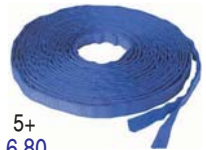

Cable Clips

Tidy up your cables to avoid accidents. For CPU, monitor, and printer cables. Includes adhesive name labels.

CNA#	1-4	5+
89-871	4.55	3.90



Cable Ties

100 per package.

CNA#	1-4	5+
A 89-860	4"	1.25 .99
A 89-880	8"	2.45 1.95
A 89-890	15"	6.10 5.95
B 89-895	3/4" Sq.	7.90 7.40

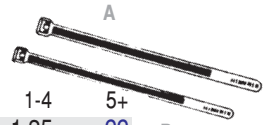

Cable Tie Gun

Cable tie width from 3/32" - 11/32". Neatly cuts end of cable tie off. Adjustable tension control.

84-850	21.50
--------	-------





11 Piece Tool Kit

11 Piece tool kit includes chip inserter and comes with vinyl zipper case.

CNA# 1-4 5+
89-810 9.50 8.75



23 Piece Tool Kit

23 piece computer tool kit with vinyl carrying case includes soldering iron, IC extractor, IC inserter, assorted screwdrivers, all-in-one crimper, plus more.



26.50

Field Service Tool Kit

Soldering Iron, Desoldering Pump, Utility Knife, 2 pc. Alignment Tool Set, Solder Core, Screwdriver (+6 x 100 mm), Electrical Test Scredriver, Anti-static Wrist Wrap, 6 pc. Precision Screwdriver, 8" Wire Stripper Plier, 5" Wire Stripper Plier, 6" Line's Man Plier, 6" Long Nose Plier, 8 pc. 9" Coax Crimping Tool, IC Extractor, Soldering Stand, Part Box, Digital Multimeter, Screwdrivers (5.0 x 75 mm +5.0 x 75 mm), 3.2 x 75 mm +3.2 x 75 mm



149.50

Aluminum Tool Case

Rugged case with movable portions and carrying strap. Removable pallet with tool pockets. 18" x 13.5" x 6.25"



CNA# 84-829 49.00

Digital Pocket Multimeter

Diode and 50-Ohm Continuity Beeper 2V-500V DC, 200V-500V AC, 2K-2M Ohms and Leatherette Pouch

CNA# 84-070 9.75



PVC Electrical Tape

60' 600V UL, 176 Degrees

CNA# 84-189 1-4 5+
.95 .89



Professional Telecom Tool

Professional telecom tool with full ratcheting action. Crimps handset, RJ11, RJ12 and RJ45 connectors. Includes wire stripper and cutter. Ergonomic handles and hardened jaws for long life.

CNA# 84-820C 29.50



Universal Crimping Tool

Full ratcheting cycle with manual ratchet release. Ergonomic handles and hardened jaws for long life. See list below for Die Sets that fit this frame.



CNA#		
84-830	Crimping Tool (Frame Only)	19.75
84-847	RG58/59/62AU BNC/TNC Die Set	13.75
84-849	RG58/58AU, RG59/62 Teflon Die Set	13.75
84-831	RG58/174, Die Set	13.75
84-839	RG6/58 BNC/TNC Die Set	13.75
84-846	RJ11 Modular Plugs Die Set	13.75
84-832	RJ45 Modular Plugs Die Set	13.75
84-841	Insulated Term AWG 26-14 Die Set	13.75
84-842	Insulated Term AWG 22-12 Die Set	13.75
84-835	Uninsulated Term AWG 22-12 Die Set	13.75
84-836	Open Barrel AWG 22-12 Die Set	13.75

Jewelers Screwdriver Set

4 Slotted 1.4,2.0,2.4,2.9mm, 2 Phillips #0,#1. Swivel-Top Knurled Handles.

CNA# 89-111 1-4 5+
2.25 1.95



6 Pc. Precision Screwdriver Set

#0, #1, #2 phillips, 2.4 x 75mm, 3.0 x 100mm, & 3.8 x 150mm straight blade.

84-826 5.90



Magnetic, Telescopic Pick-up tool



Screwdriver handle style with magnetic tip. Extends to approx. 16".
84-833 3.90

Visit us on the web for our complete product line

www.FastComputerParts.com

800-516-1262

32 Fax: 800-236-5672

Precision Wire Stripper

Plier nose. Cutter jaws. Soft grip handles. Spring return.

For AWG 30, 28, 26, 24, 22, & 20
84-823

For AWG 20, 18, 16, 14, 12, & 10
84-824



9.50

9.25

Auto Wire Stripping Tool

Strips PVC, teflon & silicone wires. Strips AWG 22, 16, 14, 12, 10, & 8 wire.

Aluminum die cast.
84-815



12.25

5" Needle-Nosed Pliers

Smooth cushion grip with spring-loaded handles and serrated jaw. Great for bending and cutting copper and other soft leads.

84-844



4.99

5" Bent-Nosed Pliers

Smooth cushion grip with spring-loaded handles and serrated jaw.

84-837



5.49

5" Diagonal Cutters

Smooth cushion grip with spring-loaded handles. Cutting copper and other soft leads.

84-822



4.99

Cable Cutter

Carbon steel, hardened & black oxide finish for standard copper wire & small jacketed cables. Range up to 0.40" diameter.

84-848



7.50

"Helping Hands"

Soldering Aid

Table top, weighted base. Multidimensional adjustment capability. Alligator style clips for holding work.

84-828



4.90

30 Watt Pencil Soldering Iron



CNA#

84-105

Bakelite Construction, 1/8" Tip.

1-4 5+

84-112

Replacement Tip

3.49 2.99

.38 .27

40 Watt Pencil Soldering Iron



CNA#

84-130

Bakelite Construction, Rubber-Grip, Nickel-Plated Iron Clad, Conical Tip.

1-4 5+

84-132

Replacement Tip

8.66 7.74

2.65 2.07

Soldering Iron Stand

Non Heat-Sinking Spring Funnel, Cooling Tray and Sponge.

CNA#

84-180

1-4

5+

4.55

3.84



Desoldering Pump

CNA#

84-170

Anti-Static, Aluminum-Plastic Construction, Self Cleaning, Rugged Teflon Tip.

1-4 5+

84-172

Replacement Tip

4.90 4.20

1.45 1.10



Desoldering Braid

0.1" x 5' Copper desolder braid.

CNA#

84-168

1-4

5+

1.50

1.25



Solder Tube

AWG18, 0.040", 60/40 Rosin Core, 370 Degree Melting Point.

CNA#

84-150

Tube

.95

.83

84-155

1lb Roll

7.50

6.95



Professional Wire Cutters

For Copper and Aluminium wire up to 6AWG

84-809



11.50

Laser Toner Cartridges

CNA#	Printer Support	OEM #	Price
31-325	Brother TN 200/250/300/5000-Univ	TN250/300	15.50
31-339	Brother TN 430/460/560/570-Univ	TN430/460/560	49.95
31-319	Brother HL 600/630/645/650/655/660	TN100HL	15.50
31-323	Brother HL 700/720/730/1040/1050/1060	TN200HL	15.50
31-239	Brother DCP7020, HL2040/2070N, MFC7420/7820N	TN850	49.50
31-390	Canon FX2 Laser Class 5000/5500/7000/75000	FX2	49.10
31-326	Canon FX3 CFX-L4000/MultiPass L6000	FX3	58.50
31-308	Canon FX4 L9000/L9500/L8500	FX4	49.50
31-413	Canon FX7 F170/720/730	FX7	69.75
31-310	Canon PC 310/330/E16/E20/E30/E31/E40/300/700/900/200/500	E31/E40	79.25
31-240	Canon PC 1060/1080	L50	59.25
31-231	Canon Image Class 2210/2220/2250	EP-62	79.25
31-248	Dell P1700 Hi-Yield	310-5402	99.25
31-226	Dell M5200/5300	310-4131	109.25
31-303	HP 2/3/2D/3D/ Canon EP-S/SX/Apple LW 2/2NT/2NTX	HP92295A	32.50
31-386	HP 3Si/4Si/4SIMX(NX)	HP92291A	49.50
31-335	HP 4/4M/4Plus/4M Plus/(EX)/Apple Laser Pro 600	HP92298A	39.30
31-360	HP 4/4M/4Plus/4M Plus/(EX)/Apple Laser Pro 600 (Jumbo)	HP92298X	51.95
31-347	HP 4L/4ML/4P/4MP/(PX)/Apple Personal LW 300/320	HP92274A	42.80
31-317	HP 4V/4MV/(BX)	HPC3900A	62.95
31-329	HP 5 Si/5Si/Mopier 5SiMX/8000/8000N/Lexmark Optra N (WX)	HPC3909A	75.50
31-380	HP 5P/5MP/6P/6PX/6PXE/6MP/6RE/6PSE/(VX)	HPC3903A	42.50
31-396	HP 5L/5Lxtra/5LFS/6L/6LSe/6LSI/(AX)	HPC3906A	39.00
31-306	HP 1000/1200/1220	C7115X	54.95
31-434	HP 1010/1012/LT3015/3020/3030	Q2612A	44.50
31-398	HP 1100/1100A/1100ASE/1100SE/1100XL	HPC4092/93	44.50
31-234	HP 1160/1320 with Chip	Q5949A	63.50
31-427	HP 1300 Jumbo	Q2613X	55.50
31-427	HP 1320 Hi-Yield with Chip	Q5949X	78.50
31-225	HP 2100/2100M/2100SE/2100TN/2200 Series	C4096A	52.50
31-227	HP 2300 Series with Chip	Q2610A	72.50
31-233	HP 2400 Series with Chip	Q6511A	109.50
31-322	HP 4000/4000N/4000T/4000TN/4050/4050N/4050SE/4050T	HPC4127X	55.50
31-315	HP 4100 Series with Chip	C8061X	78.75
31-424	HP 4200 Series with Chip	Q1338A	99.75
31-247	HP 4250/4350 with Chip	Q5942A	105.75
31-245	HP 4250/4350 Hi-Yield with Chip	Q5942X	135.75
31-430	HP 4300 Series with Chip	Q1339A	109.75
31-351	HP Color LaserJet 4500/4550 Black	C4191A	39.00
31-353	HP Color LaserJet 4500/4550 Cyan	C4192A	59.95
31-356	HP Color LaserJet 4500/4550 Magenta	C4193A	59.95
31-354	HP Color LaserJet 4500/4550 Yellow	C4194A	59.95
31-426	HP Color LaserJet 4600 Black	C9720A	109.75
31-444	HP Color LaserJet 4600 Cyan	C9721A	109.75
31-456	HP Color LaserJet 4600 Magenta	C9722A	109.75
31-453	HP Color LaserJet 4600 Yellow	C9723A	109.75
31-377	HP 5000/5000N/5000GN	C4129X	79.75
31-423	HP 8100/8100DN/8100MFP/8100N/Mopier 320	C4182X	78.25
31-336	Lexmark/IBM Optra E 310/312	3T0101	98.50
31-391	Lexmark/IBM Optra E 320/322	08A0477	89.95
31-338	Lexmark/IBM Optra SE	12A0825	108.25
31-410	Lexmark T520/T522	12A6735	119.95
31-401	Lexmark T620/T622	12A6865	119.95
31-228	Lexmark T630/632/634	12A7365	129.95
31-359	Lexmark/IBM 4049 Optra R/R+/RXL/LX/Lxi	1382100/150	99.40
31-344	Lexmark/IBM 4059 Optra S/4059/1200/1250/1650/2450	1382625/20	89.00
31-362	Okidata 4w/Okioffice 44	52106201	9.90
31-348	Panasonic KX-P4450/4451/4455	KX-P	17.10
31-260	Tektronix Phaser 8200 (5 Black)	016-2040	69.95
31-255	Tektronix Phaser 8200 (5 Magenta)	016-2046	114.95
31-242	Tektronix Phaser 8200 (5 Yellow)	016-2047	114.95
31-275	Tektronix Phaser 8200 (5 Cyan)	016-2045	114.95



Only our most popular models are listed. Call today if you can't find the item you need!

Visit us on the web for our complete product line

www.FastComputerParts.com

800-516-1262

34 Fax: 800-236-5672

Remanufactured Inkjet Cartridges

Canon Remanufactured Cartridges

CNA#	Printer Support	Ink Color	OEM #	Price
31-143	BJ-10/20/200/210/230/240/Apple I, II	Black	BC-02	19.90
31-291	BJC-210/240/250 (Remanufactured)	3 Color	BC-05	22.90
31-147	BJC 4000	Black	BC-20	19.90
31-145	FAX B-540/550/800	Black	BX-3	19.90



Hewlett Packard Cartridges

31-105	HP 10, 2000C/2500C Pro Series	Black	C4844	18.90
31-109	HP 10, 2000C/2500C Pro Series	Cyan	C4841	18.90
31-115	HP 10, 2000C/2500C Pro Series	Magenta	C4842	18.90
31-123	HP 10, 2000C/2500C Pro Series	Yellow	C4843	18.90
31-101	HP 25, 310/320/340/500C/540/550C	Color	51625A	22.90
31-119	HP 26, Deskjet 400/500	Black	51626A	18.90
31-116	HP 29, Deskjet 600 Series (Except 610/612)	Black	51629A	17.90
31-122	HP 49, Deskjet 600 Series	Color	51649A	22.90
31-120	HP 45, Deskjet 700/800/900/1000/1600 Series	Black	51645A	12.90
31-125	HP 41, Deskjet 800/1000/1150 Series	Color	51641A	17.90
31-128	HP Deskjet 840C Series	Color	HP C6625AN	19.90
31-124	HP 23, Deskjet 700/810/880/890/895/1120 Series	Color	C1823D	17.90
31-121	HP 20, Deskjet 610/612	Black	C6614A	17.90
31-118	HP Deskjet 810/812/840	Black	HP C6615A	13.90
31-129	HP 78, Deskjet 930/950/970/1000/1100 Series	Color	C6578D	17.90
31-110	HP 27, Deskjet 3320/3420/3520/3620/3650	Black	C8727A	19.90
31-100	HP 28, Deskjet 3320/3420/3520/3620/3650	Color	C8728A	21.90
31-106	HP 56, Deskjet 5650/5550 Office Jet 4110/6110	Black	C6656A	19.90
31-112	HP 57, Deskjet 5650/5550 Office Jet 4110/6110	Color	C6657A	22.90
31-102	HP 21, Deskjet 5440, PhotoSmart 7850, 1510	Black	C9351AN	13.50
31-104	HP 22, Deskjet 3920/3930, PSC 1410/1417	Color	C9352AN	17.90
31-108	HP 92, Deskjet 5440, PSC 1507/1510	Black	C9362WN	14.90
31-111	HP 93, Deskjet 5440, PSC 1507/1510	Color	C9361WN	16.90
31-113	HP 94, Deskjet 5440, PSC 1507/1510	Black	C8765WN	16.90
31-114	HP 95, Deskjet 5740/6540/6840	Color	C8766WN	18.90
31-142	HP 96, Deskjet 5740/6540/6840	Black	C8767WN	19.90
31-152	HP 97, Deskjet 5740/6540/6840	Color	C9363WN	20.90



Lexmark Cartridges

31-150	Lexmark Z12/Z22/Z32	Black	16G0050/55	23.90
31-157	Lexmark Z12/Z22/Z32	Color	16G0060/65	23.90
31-154	Lexmark Z42/Z43/Z51/Z52/Z82/Z83	Black	15M0120/125	23.90
31-138	Lexmark 5700/7000/Z11/Z31/Z51/Z52/Z82/Z83	Black	12A1970/75	23.90
31-134	Lexmark 5700/7000/Z11/Z31/Z51/Z52/Z82/Z83	Color	12A1980/85	23.90
31-136	Lexmark Z55/Z65/X5150/X6150	Black	18L0032	23.90
31-133	Lexmark Z55/Z65/X5150/X6150	Color	18L0042	23.90
31-131	Lexmark Z23/Z25/Z35	Black	10N0016	23.90
31-139	Lexmark Z23/Z25/Z35	Color	10N0026	23.90



Dot Matrix Printer Ribbons

Compatible Ribbons for P.O.S. machines and computer printers.
Quality GUARANTEED equal to O.E.M. Generic Packaging.

31-687	Citizen GS-X 130/140/200	Black	2.70
31-660	Epson DFX 5000/DFX 8000	Black	8.90
31-668	Epson FX/MX-80/LX300/LX800	Black	2.40
31-692	Epson LQ 200/500/570/800/870	Black	2.80
31-696	Epson LQ 1000/1050/1070/1170	Black	2.90
31-657	Oki ML 180/190/320/380/390 Series Seamless	Black	2.80
31-665	Oki ML 393/393C	Black	7.90
31-680	Oki ML 590/591	Black	2.90
31-676	Panasonic 1080/1090/1180/1595/1123/1124 Seamless	Black	2.90
31-698	Panasonic 1524/1624/2624/3624	Black	3.40
31-682	Panasonic 2123/2124/2180	Black	3.40
31-655	Star NX 1000	Black	1.90
31-651	Star NX 2400	Black	2.70



Brother Compatible Cartridges

CNA#	Printer Support	Ink Color	OEM #	Price
31-790	MFC-210/3240/3340/5540/5840 FAX-420/620	Black	LC41BK	2.90
31-793	MFC-210/3240/3340/5540/5840 FAX-420/620	Cyan	LC41C	2.90
31-794	MFC-210/3240/3340/5540/5840 FAX-420/620	Magenta	LC41M	2.90
31-791	MFC-210/3240/3340/5540/5840 FAX-420/620	Yellow	LC41Y	2.90
31-754	MFC-4420C/4820C	Black	LC25BK	3.75
31-764	MFC-4420C/4820C	Cyan	LC25C	2.90
31-742	MFC-4420C/4820C	Magenta	LC25M	2.90
31-739	MFC-4420C/4820C	Yellow	LC25Y	2.90
31-788	MFC-7000FC/7200FC	Black	LC01BK	2.90
31-759	MFC-7000FC/7200FC	Cyan	LC01C	2.40
31-765	MFC-7000FC/7200FC	Magenta	LC01M	2.40
31-753	MFC-7000FC/7200FC	Yellow	LC01Y	2.40
31-785	MFC-7150C/7160C/9100C	Black	LC02BK	2.90
31-795	MFC-7150C/7160C/9100C	Cyan	LC02C	2.40
31-767	MFC-7150C/7160C/9100C	Magenta	LC02M	2.40
31-780	MFC-7150C/7160C/9100C	Yellow	LC02Y	2.40
31-750	MFC-3100/5100/5200	Black	LC21BK	2.90
31-734	MFC-3100/5100/5200	Cyan	LC21C	2.40
31-743	MFC-3100/5100/5200	Magenta	LC21M	2.40
31-757	MFC-3100/5100/5200	Yellow	LC21Y	2.40
31-760	MFC-3220/3320/3420	Black	LC31BK	2.90
31-770	MFC-3220/3320/3420	Cyan	LC31C	2.40
31-770	MFC-3220/3320/3420	Magenta	LC31M	2.40
31-777	MFC-3220/3320/3420	Yellow	LC31Y	2.40

Canon Compatible Cartridges

CNA#	Printer Support	Ink Color	OEM #	Price
31-290	BJC-7050/80/BJ-30	Black	BCI-10	4.90/3PK
31-218	BJC-7050/80	Black	BCI-11BK	4.50/3PK
31-211	BJC-7050/80	Color	BCI-11C	6.90/3PK
31-201	BJC-600/600e/610/620 (Hi-Cap)	Black(15ML)	BJI-201HC	3.40/2PK
31-249	BJC-600/600e/610/620	Cyan(12ML)	BJI-201C	3.40/2PK
31-220	BJC-600/600e/610/620	Magenta(12ML)	BJI-201M	3.40/2PK
31-287	BJC-600/600e/610/620	Yellow(12ML)	BJI-201Y	3.40/2PK
31-243	BJC-800 Series	Black	BJI-6BK	2.50
31-270	BJC-800 Series	Cyan	BJI-6C	2.50
31-277	BJC-800 Series	Magenta	BJI-6M	2.50
31-250	BJC-800 Series	Yellow	BJI-6Y	2.50
31-280	BJC-3000/6000 Series	Black	BCI-3EBK	2.50
31-224	BJC-3000/6000 Series	Cyan	BCI-3EC	1.90
31-281	BJC-3000/6000 Series	Magenta	BCI-3EM	1.90
31-209	BJC-3000/6000 Series	Yellow	BCI-3EY	1.90
31-214	BJC-3000/6000 Series	(Photo Black)	BCI-3EPB	1.90
31-289	BJC-3000/6000 Series	(Photo Cyan)	BCI-3EPC	1.90
31-253	BJC-3000/6000 Series	(Photo Magenta)	BCI-3EPM	1.90
31-210	BJC-4000/2000 Series	Black	BCI-21B	1.40
31-212	BJC-4000/2000 Series	3 Color	BCI-21C	1.90
31-219	BJC-8200/S800/S820/S900	Black	BCI-5BK	1.90
31-221	BJC-8200/S800/S820/S900	Cyan	BCI-5C	1.90
31-269	BJC-8200/S800/S820/S900	Magenta	BCI-5M	1.90
31-283	BJC-8200/S800/S820/S900	Yellow	BCI-5Y	1.90
31-206	BJC-8200/S800/S820/S900	(Photo Cyan)	BCI-5PC	1.90
31-258	BJC-8200/S800/S820/S900	(Photo Magenta)	BCI-5PM	1.90
31-149	BJC-8500 Series	Black	BCI-8B	6.40
31-159	BJC-8500 Series	Cyan	BCI-8C	5.90
31-151	BJC-8500 Series	Magenta	BCI-8M	5.90
31-146	BJC-8500 Series	Yellow	BCI-8Y	5.90
31-156	BJC-8500 Series	(Photo Black)	BCI-8PBK	5.90
31-141	BJC-8500 Series	(Photo Cyan)	BCI-8PC	5.90
31-153	BJC-8500 Series	(Photo Magenta)	BCI-8PM	5.90
31-252	i70	Black	8190A003	3.90/2PK
31-262	i70	Color	8191A003	4.90/2PK
31-265	S200/S300	Black	BCI-24B	1.60
31-279	S200/S300	3 Color	BCI-24C	2.60



Only our most popular models are listed. Call today if you can't find the item you need!

Visit us on the web for our complete product line

www.FastComputerParts.com

800-516-1262

36 Fax: 800-236-5672

Epson Remanufactured Cartridges

CNA#	Printer Support	Ink Color	OEM #	Price
31-502	Picture Mate	6 Color	P5570	14.50
31-835	Stylus C42UX	Black	T036120	4.40
31-845	Stylus C42UX	3 Color	T037020	4.90
31-536	Stylus Cir 440/640/660/StylusPhoto 750/1200	Black	S020187	3.25
31-585	Stylus Cir 440/640/660/740/740/760/860/1160	3 Color	S020191	4.90
31-537	Stylus Color 480/580/C40UX	Black	T013201	3.25
31-539	Stylus Color 480/580/C40UX	3 Color	T014201	4.25
31-508	Stylus C60	Black	T028201	4.40
31-519	Stylus C60	3 Color	T029201	4.90
31-860	Stylus C62	Black	T040120	4.90
31-865	Stylus C62	3 Color	T041020	4.90
31-513	Stylus C64/C84/CX6400	Black	T044120	5.90
31-533	Stylus C64/C84/CX6400	Cyan	T044220	5.90
31-553	Stylus C64/C84/CX6400	Magenta	T044320	5.90
31-573	Stylus C64/C84/CX6400	Yellow	T044420	5.90
31-521	Stylus Photo 750	5 Color	S020193	4.90
31-540	Stylus Photo 1200	5 Color	T010111	5.25
31-526	Stylus Color 740/740/760/860/1160	Black	S020189	3.25
31-555	Stylus Cir 400/500/600/Stylus Photo 700/EX	Black	S020093	3.25
31-544	Stylus Photo/700 Photo EX	5 Color	S020110	4.90
31-524	Stylus Color 777	Black	T017201	4.90
31-529	Stylus Color 777	3 Color	T018201	5.20
31-594	Stylus C68/88/CX3800/3810/4200/4800/7800	Black	T060120	5.90
31-598	Stylus C68/88/CX3800/3810/4200/4800/7800	Cyan	T060220	5.90
31-591	Stylus C68/88/CX3800/3810/4200/4800/7800	Magenta	T060320	5.90
31-596	Stylus C68/88/CX3800/3810/4200/4800/7800	Yellow	T060420	5.90
31-542	Stylus C80/C82/CX5200/CX5400	Black	T032120	5.90
31-569	Stylus C80/80N	Cyan	T032220	5.90
31-589	Stylus C80/80N	Magenta	T032320	5.90
31-551	Stylus C80/80N	Yellow	T032420	5.90
31-843	Stylus C82/82N/CX5200/CX5400	Cyan	T042220	5.90
31-853	Stylus C82/82N/CX5200/CX5400	Magenta	T042320	5.90
31-863	Stylus C82/82N/CX5200/CX5400	Yellow	T042420	5.90
31-561	Stylus R200/220/300/320/340/RX500/600/620	Black	T048120	5.90
31-564	Stylus R200/220/300/320/340/RX500/600/620	Cyan	T048220	5.90
31-566	Stylus R200/220/300/320/340/RX500/600/620	Magenta	T048320	5.90
31-562	Stylus R200/220/300/320/340/RX500/600/620	Yellow	T048420	5.90
31-565	Stylus R200/220/300/320/340/RX500/600/620	Lt. Cyan	T048520	5.90
31-570	Stylus R200/220/300/320/340/RX500/600/620	Lt. Magenta	T048620	5.90
31-557	Stylus Photo R800/RX700	Gloss Option	T054020	5.90
31-549	Stylus Photo R800/RX700	Black	T054120	5.90
31-556	Stylus Photo R800/RX700	Cyan	T054220	5.90
31-554	Stylus Photo R800/RX700	Magenta	T054320	5.90
31-520	Stylus Photo R800/RX700	Yellow	T054420	5.90
31-559	Stylus Photo R800/RX700	Red	T054720	5.90
31-567	Stylus Photo R800/RX700	Blue	T054920	5.90
31-547	Stylus Photo R800/RX700	Matte Black	T054820	5.90
31-574	Stylus Cir 800/850/N/Ne/1520	Black	S020108	3.25
31-523	Stylus Cir 800/850/N/Ne/400/600/1520	3 Color	S020089	3.90
31-576	Stylus Photo 810/820	Black	T026201	4.40
31-584	Stylus Photo 810/820	5 Color	T027201	4.90
31-532	Stylus Color 870/875/1270/1280	Black	T007201	3.60
31-552	Stylus Color 825/870/875	5 Color	T008201	4.25
31-525	Stylus Color 1270/1280	5 Color	T009201	4.90
31-541	Stylus Color 880	Black	T019201	4.40
31-543	Stylus Color 880	3 Color	T020201	4.90
31-592	Stylus Color 900/900N/900G/980	Black	T003011	2.90
31-501	Stylus Color 900/900N/900G/980	3 Color	T005011	3.90
31-510	Stylus Photo 950/960	Black	T033120	5.90
31-505	Stylus Photo 950/960	Cyan	T033220	5.90
31-518	Stylus Photo 950/960	Magenta	T033320	5.90
31-522	Stylus Photo 950/960	Yellow	T033420	5.90
31-531	Stylus Photo 950/960	Photo Cyan	T033520	5.90
31-515	Stylus Photo 950/960	Photo Magenta	T033620	5.90
31-516	Stylus Photo 2200	Black	T034120	5.90
31-535	Stylus Photo 2200	Cyan	T034220	5.90
31-550	Stylus Photo 2200	Magenta	T034320	5.90
31-514	Stylus Photo 2200	Yellow	T034420	5.90
31-504	Stylus Photo 2200	LT Cyan	T034520	5.90
31-546	Stylus Photo 2200	LT Magenta	T034620	5.90
31-502	Stylus Photo 2200	LT Black	T034720	5.90
31-563	Stylus Photo 2200	Matte Black	T034820	5.90
31-568	Stylus Photo R2400	Black	T059120	6.90





3.5" Hard Drives

Western Digital

7200 RPM

CNA#	Capacity	Price
87-615	IDE 80.0 GB	45.00
87-611	IDE 120.0 GB	53.00
87-606	IDE 160.0 GB	59.00
87-613	IDE 200.0 GB	76.00
87-679	SATA 80.0 GB	49.00
87-674	SATA 160.0 GB	69.00

Call for other sizes and types

DVD/CD-ROM/CD-RW Drives



CNA#	Model	Price
87-687	56x CD-ROM, IDE	19.50
87-685	56x CD-ROM, IDE, Black	19.50
87-702	52x32x52 CD-RW, IDE	26.00
87-730	52x32x52 CD-RW, IDE, Black	26.00
87-723	CD-RW/DVD Combo, IDE	29.00
87-719	CD-RW/DVD Combo, IDE, Black	29.00
87-682	16x DVD, IDE	26.00
87-684	16x DVD, IDE, Black	26.00
87-731	DVR Recordable DVD, IDE	38.00
87-733	DVR Recordable DVD, IDE, Black	38.00

Floppy Drive



CNA#	Model	Price
87-676	3.5", 1.44MB	9.75
87-683	3.5", 1.44MB, Black	9.75

FastComputerParts.com

Removable Hard Drive Racks

Removable frame for 3.5" hard drives. This easy-to-install rack allows you to remove your drive. Fits into a 5-1/2" bay.



CNA#	Capacity	Price	Price
85-479	IDE 33/66/100/133 w/Fan	12.90	10.90
85-477	Serial ATA 150	12.90	10.90
85-474	SCSI with Cooling Fan	19.50	17.50
85-478	SCSI-UW with Fan	46.50	44.50

Sound Cards with Built-In 3D Sound



CNA#	Model	Price
87-951	ISA Advanced Logic 16bit	9.25
87-967	PCI Crystal 3D Sound	9.50
87-931	PCI Sound Blaster Live 7.1	29.50

56K/V.90 Modems Voice/Fax/Data



CNA#	Model	Price
87-985	PCI Internal Win	7.90
87-992	USB External	19.90
87-713	PCMCIA External	34.00

PCI Controller Cards



CNA#	Model	Price
87-947	Dual SATA 150	24.50
87-609	5 Port USB 2.0 480 Mbps	9.90
87-938	Single Parallel Port (ECP/EPP/SPP)	19.50
87-695	Single Serial (DB9) Port, Hi-Speed	19.50
87-697	Dual Serial (DB9) Port, Hi-Speed	24.50
87-959	Ultra SCSI-II	37.50
87-954	Ultra Wide SCSI-III	64.25
87-946	Ultra IDE 33/66 with RAID	19.50
87-942	Ultra IDE 33/66/100/133 with RAID	39.50

PCI to USB 2.0 Controller Card

Fully Plug and Play for Windows® 98/2000/ME/XP.

CNA#	Model	Price
87-609	5 Port (2.0) 480 Mbps	9.90

PCI to FireWire IEEE 1394 Host Adapter

3 External + 1 Internal Ports. IEEE 1394/FireWire ports at 100/200/400 Mbps per second.

CNA#	Price
87-994	11.50

FireWire and USB PCMCIA Cards

Adds Firewire or USB ports to any notebook computer.

CNA#	Model	Price
87-883	USB 2.0	19.00
87-881	Firewire	28.50



Visit us on the web for our complete product line

www.FastComputerParts.com

800-516-1262

38 Fax: 800-236-5672

4U Rack Mount Case w/Locking Door

Generally accepted industrial standard 19" rack-mount chassis. ATX form factor. PS/2 style power supply sold separately.



CNA#
87-643 Black, 19"(W) x 7"(H) x 18.5"(D) **149.00**

External Drive Boxes

For converting internal HDD, CD-ROM, and Optical Drives to external devices.



CNA#			
87-634	2.5", USB 2.0 to IDE		9.90
87-640	2.5", USB 2.0 to SATA		15.90
87-663	3.5", USB 2.0 to IDE		22.50
87-647	3.5", USB 2.0 to SATA		23.90
87-660	5.25", USB 2.0 to IDE		28.00
87-628	5.25", USB 2.0/FireWire to IDE		49.00
87-673	3.5", SCSI-I to SCSI-I		49.00
87-656	3.5", SCSI-III to SCSI-III		69.00
87-665	3.5", Parallel Port to IDE		69.00
87-654	5.25", Parallel Port to IDE		69.00
87-662	3.5", PCMCIA to IDE		79.00
87-667	5.25", PCMCIA to IDE		79.00

Drive Mounting Kits

3-1/2" drive mounting kits for 5-1/4" bays.

CNA#		1-4	5+
85-484	Floppy	.69	.59
85-485	Hard Drive	1.90	1.60

2-1/2" drive mounting kits for 3-1/2" bays.

CNA#		8.50	7.90
85-487	IDE	8.50	7.90
85-489	SCSI	12.00	11.40

PC Case Brackets

CNA#		1-9	10+
85-522	Blank Plate	.60	.45
85-523	DB9 Cut-Out	.65	.50
85-524	DB25 Cut-Out	.65	.50
85-527	DB25 and DB9 Cut-Out	.65	.50

PCI TV Tuner and Capture Card

The Model-60X multimedia PCI card uses the Bt848A chip. 181 full-channel TV tuner including broadcast and cable. 24 bit color at up to 30 frames per second. Support 640x480 up to 1280x1024, 16.7 million colors.



87-691 TV Tuner & Capture Card **26.75**

Micro ATX Mid Tower Case

Includes 300W ATX power supply with P4 connectors. (2) 5.25", (2) 3.5" exposed bays and (1) 3.5" hidden bays. Two front USB ports.



CNA#
87-632 Black, 7"(W) x 14.2"(H) x 15.35"(D) **49.50**

ATX/AT Mini/PS2 Power Supplies

UL approved 115/230V Switchable, 50/60Hz.



CNA#			
87-637	ATX20/ATX24/P4, 350 Watts		29.50
87-734	ATX20/ATX24/P4, 500 Watts		67.50
87-639	AT, 300 Watts, (4)5.25" and (1)3.5"		29.90

230w MATX/E-Machine Power Supply

UL approved 115/230V switchable power supply. 5"(W) x 2.5"(H) x 4"(D)



87-635 MATX, (4)5.25" and (1)3.5" **29.50**

ATX Power Supply Adapters

CNA#		1-4	5+
85-539	20 Pin Male to 24 Female	3.35	2.90
85-537	24 Pin Male to 20 Female	3.35	2.90

Power Supply Tester

Simple tester for switching power supplies. Test 20P/24P ATX, 4P Power, P4 and Floppy connectors.

CNA#	1-4	5+
78-119	12.90	12.25



External Power Panels

Great for attaching external devices to your PC. Front panels fit in a 3.5" drive opening and rear fit a PC slot.

85-544	Front IDE and Power	5.80
85-526	Front SATA and Power	5.80
85-528	Rear SATA, Power and 3P Fan	5.80
85-546	Rear (2) 4P Power and (2) 3P Fan	5.80





CPU Cooling Fans

Extend your CPUs life with these low profile, low noise, ball-bearing cooling fans with heatsink.



CNA#	CPU Type	Plug Type	1-4	5up
89-582	Socket 478, Pentium 4 (Ball Bearing) Up to 2.4GHz	3 Pin	9.90	9.50
89-604	Socket 478, Pentium 4 (Ball Bearing) Up to 3.4GHz	3 Pin	15.50	14.90
89-607	Socket 775, Pentium 4 (Ball Bearing) Up to 3.8GHz	3 Pin	16.90	15.90
89-592	Socket A, 370, K6, Thunderbird, Duron, Intel FCPGA (Ball Bearing)	3 Pin	6.40	5.90
89-583	Socket A, 370, K6, Athlon XP, Thunderbird, Duron, Intel FCPGA (Ball Bearing)	3 Pin	7.10	6.50
89-589B	Socket 7, AMD K-5, Pentium (Ball Bearing)	3 or 4 Pin	5.90	5.60
89-595B	Slot 1, Pentium II Original (Ball Bearing)	3 Pin	7.50	6.90
89-599	Slot 1, Pentium II, III, SECC 2 (Ball Bearing)	3 Pin	8.25	7.70
89-600	Slot A, AMD K7 Athlon, Dual Fan (Ball Bearing)	3 Pin	11.25	10.75
89-589B	486 CPU's (Ball Bearing)	4 Pin	5.90	5.60

Heat Sink Compound

Silicone Grease

CNA#	1-4	5up
89-671	Single App .36	.29
89-673	Syringe 4 App .95	.79



12V Power Supply and Case Fans

CNA#	1-4	5up
89-322	3-1/8" Sq. x 1" (80x80x25) Sleeve Bearing, 4 Pin	1.89 1.49
89-322B	3-1/8" Sq. x 1" (80x80x25) Ball Bearing, 4 Pin	4.40 3.90
89-328	3-1/8" Sq. x 1" (80x80x25) Ball Bearing, 3 Pin	4.40 3.90
89-326	3-5/8" Sq. x 1" (90x90x25) Sleeve Bearing, 4 Pin	3.10 2.60
89-321	2-3/8" Sq. x 3/4" (60x60x10) Ball Bearing, 4 Pin	4.40 3.90
89-324	1-1/2" Sq. x 3/8" (40x40x10) Ball Bearing, 4 Pin	4.40 3.90
89-330	Fan Screws - 4 Pack	.25 .19



www.FastComputerParts.com

3 Pin to 4 Pin Adapter Cables

Allows 3P CPU fans to be used with 4P power supplies connectors.

CNA#	1-9	10+
85-533	3P Male to 4P Male	.99 .75
85-529	3P Female to 4P Female	1.20 .90



PC Air Conditioner

Keep the interior of your PC air conditioned. Adjustable fan position to cool the most heated area.

CNA#	1-4	5+
89-488	18.00	16.90



3-1/2" Drive Bay System Cooler

Great for Hard Drive and CD-Rom cooling.

CNA#	1-4	5+
89-495	12.90	12.25



The System Cooler

The system cooler gives you complete circulation throughout your PC.

CNA#	1-4	5+
89-490	5.50	4.90



Hard Disk Cooler

Extends HDD life span. Easy installation and maintenance free. Standard DC fan.

CNA#	1-4	5+
89-482	6.40	5.90

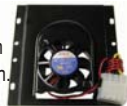

Visit us on the web for our complete product line

www.FastComputerParts.com

800-516-1262

40 Fax: 800-236-5672

P4/478 Fan Retainer Set

Plastic replacement P4/478 CPU fan retainer set for motherboards.

CNA#	1-4	5+
89-492	2.25	1.90



CMOS Battery

Lithium replacement for expansion real time clocks. CR2032 (3 Volts).

CNA#	1-4	5+
85-325	2.10	1.80



Computer Case Speed Screws

Quick and easy assembly of computer cases. Package of 10.

CNA#	1-4	5+
89-425	2.99	2.50



Computer Assembly Kit

20 Case Screws, 20 Drive Screws, 6 MB Stand-offs, 3 MB Edge Supports, and 6 Washers

CNA#	1-4	5+
89-419	2.25	1.90



Computers Screws and Hardware



CNA#		1-4	5+
89-959	(A) PC Case - 50 Pcs/Bag	3.90	3.50
89-949	(B) Floppy - 50 Pcs/Bag	3.90	3.50
89-953	(C) CD-Rom - 50 Pcs/Bag	3.90	3.50
89-956	(D) Hard Drive - 50 Pcs/Bag	3.90	3.50
89-952	(E) Standoffs - 100 Pcs/Bag	8.40	7.90

Notebook Cooling Pad

USB powered with 4 high performance fans and adjustable speed switch. 10.5" x 12.75"

CNA#	1-4	5+
89-493	13.75	12.75



24" CD-ROM

Audio Cables

CNA#		1-24	25+
91-430	IDE to IDE	.50	.35



SATA Host to IDE

SATA host (motherboard) to IDE hard drive adapter.

CNA#	1-4	5+
180724	13.40	12.90



Drive Cables



CNA#		1-9	10+
85-184	Dual Floppy Drive Cable, 28"	1.50	1.25
85-186	Dual Floppy Drive Cable, 36"	1.93	1.54
85-208	Dual Floppy Drive, 24", Round	2.30	1.90
85-150	IDE Drive, 40 Pin, 1 Drive, 18"	1.25	.98
85-152	IDE Drive, 40 Pin, 2 Drives, 24"	1.43	1.14
85-321	IDE Drive, 40 Pin, 2 Drives, 36"	1.82	1.46
85-183	Ultra IDE, 80C, 2 Drives, 18"	2.90	2.60
85-198	Ultra IDE, 80C, 2 Drives, 36"	4.45	3.60
85-204	Ultra IDE, 2 Drives, 18", Round	3.90	3.60
85-201	Ultra IDE, 2 Drives, 24", Round	5.30	4.90
85-206	Ultra IDE, 2 Drives, 36", Round	6.40	5.50
85-140	SCSI Drive, 50 Pin, 1 Drive, 18"	1.80	1.44
85-142	SCSI Drive, 50 Pin, 2 Drives, 22"	2.20	1.76
85-148	SCSI Drive, 50 Pin, 5 Drives, 54"	3.84	3.46
85-145	SCSI Drive, 50 Pin, 6 Drives, 61"	4.30	3.90
85-147	SCSI-UW H/P DB68, 2 Devices, 36"	7.10	6.50
85-172	SCSI-UW HPDB68, 4 Devices, 54"	10.90	9.90
85-156	SCSI-UW HPDB68, 6 Devices, 74"	14.75	13.90

Serial ATA Cables



CNA#		1-5	5+
85-044	Serial ATA 150 7P-7P, 24"	1.90	1.70
85-049	Serial ATA 150 7P-7P, 40"	2.40	2.10
85-051	ATA to 5.25 Power Adapter, 6"	1.80	1.50

Power Supply Cables & Adapters



CNA#		1-9	10+
85-650	6" Power Y, 5-1/4" Drives	.99	.69
85-531	12" Power Ext. 5-1/4" M to 5-1/4" F	1.75	1.40
85-541	8" AT Motherboard Power Ext.	4.15	3.25
85-543	6" ATX Motherboard Power Ext.	4.75	4.45

P4 Adapter Cable

Adapts standard power supply to P4 motherboard, 8".

CNA#	1-9	10+
85-532	1.65	1.40



TV/Plasma/Monitor Mounts

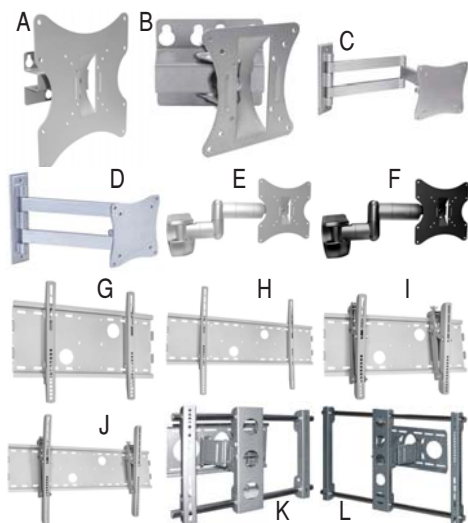

CNA#	Fig.		
502611	A	10-30"/66lbs Tilt Only	9.90
502604	B	10-30"/66lbs Tilt & Swivel	9.95
502601	C	10-30"/33lbs Tilt & Swivel	18.50
502602	D	10-30"/33lbs Tilt & Swivel	18.50
502612	E	10-30"/66lbs Tilt & Swivel	18.50
502613	F	10-30"/66lbs Tilt & Swivel	19.50
502615	H	23-37"/165lbs Stationary	34.50
502614	G	30-63"/165lbs Stationary	34.50
502609	I	23-36"/165lbs Tilt Only	34.50
502610	J	30-63"/165lbs Tilt Only	39.50
502607	K	23-37"/165lbs Tilt & Swivel	69.50
502616	L	30-63"/165lbs Tilt & Swivel	79.50

iPod Accessories

	202913	Portable Speaker System	9.50
	202909	USB Power Adapter Wall Outlet	5.90
	202906	3Ft. Retractable iPod Cable	7.50
	202905	USB Docking Station Shuffle	5.90
	202911	4Ft. Audio/Video Cable	5.90
	202910	USB Power Adapter 12V Outlet	5.90

Car Audio Play FM Transmitter

Listen to iPod, MP3 player, or CD on your car audio system. Built-in FM stereo transmitter. 3.5mm stereo plug input. Channel select.



202903 **19.90**

HDMI Cables

1080P Compatible



CNA#		1-4	5+
72-772	3' (1M) HDMI Male to Male	3.50	2.90
72-776	6' (2M) HDMI Male to Male	5.60	4.90
72-771	9' (3M) HDMI Male to Male	8.80	7.90
72-770	16' (5M) HDMI Male to Male	9.90	9.00
181205	22' (7M) HDMI Male to Male	10.50	9.50
181206	30' (10M) HDMI Male/Male	12.90	11.90
181207	50' (16M) HDMI Male/Male	75.00	72.50
181208	75' (25M) HDMI Male/Male	82.00	79.00
181209	100' (30M) HDMI Male/Male	129.50	125.00
181210	150' (50M) HDMI Male/Male	144.50	139.00
72-775	3' (1M) HDMI Male to DVI	7.50	6.90
72-779	6' (2M) HDMI Male to DVI	9.90	9.20
72-774	9' (3M) HDMI Male to DVI	10.90	10.20
72-781	16' (5M) HDMI Male to DVI	15.75	14.25
181215	22' (7M) HDMI Male to DVI	21.50	20.00
181216	30' (10M) HDMI Male to DVI	24.50	23.00

www.FastComputerParts.com

High Performance 3 RCA Component Video Cables



CNA#		1-9	10+
72-920	3' Black - 3 RCA	5.90	5.40
72-906	6' Black - 3 RCA	8.90	8.40
72-922	12' Black - 3 RCA	12.40	11.75
72-925	25' Black - 3 RCA	16.90	15.90
72-950	50' Black - 3 RCA	33.00	31.75
72-975	75' Black - 3 RCA	39.90	37.90
72-940	100' Black - 3 RCA	49.90	47.75

Universal Notebook Adapter

Providing power solutions for your mobile computing needs
AC input: 100-240V, 1.6A, 50/60Hz
Compatible with 19V input notebooks, up to a current of 4.74A, 90W max.
Six universal tips for maximum compatibility. High efficiency with complete circuit protection.

CNA#	1-4	5+
88-059	59.25	55.50



Visit us on the web for our complete product line

www.FastComputerParts.com

800-516-1262

42 Fax: 800-236-5672

Speaker Systems

Compact two speaker system designed for the value conscience consumer. It features adjustable volume control and a power button with earphone jack.



CNA#	1-4	5+
88-501 Beige	6.50	5.90

Speaker Systems

3W RMS per channel
100Hz~20KHz
6.25" (H) x 2.5" (W) x 4" (D)
3" with 3.5mm plug



CNA#	1-4	5+
310301 Black	7.90	7.40

USB Speaker Systems

(2) USB powered speakers with a built-in, super efficient Class-D digital amplifier that boosts the depth of bass, brings background music to life.



CNA#	1-4	5+
88-487 Black	9.90	9.40

USB Powered Speaker System

Super efficient three-piece multimedia speaker system features high-performance full-range drivers for stunning audio clarity of highs, mid's and lows.



CNA#	1-4	5+
88-481 Black	31.50	29.50

Bluetooth Stereo Headset

Comfortable, stylish and lightweight handsfree Bluetooth stereo headset. Features high quality stereo sound, noise suppression and echo elimination, and compatibility with current Bluetooth v1.1/1.2/2.0



Bluetooth Handsfree Headset

Compatible with all Bluetooth capable phones and devices, the Bluetooth v2.0 handsfree phone headset features echo and noise-free crystal clear quality.



103504	19.60
--------	-------

Mini Stereo Headphone

Brilliant, full dimension stereo sound.

CNA#	1-9	10+
88-521	1.99	1.69



Multimedia Headphones with Mic and Volume Control

Digital audio headphones with mic. Compatible with all PC sound cards.

CNA#	1-4	5+
88-507	4.75	4.25



Executive Stereo Headset

Boom microphone and volume control. Padded leather ear cups.

CNA#	1-4	5+
88-520	7.50	6.75



Multimedia Headphones

Deluxe stereo headphones with gold plated digital plugs. Great for computer and sound cards. Adjustable headband.

CNA#	1-4	5+
88-510	10.60	9.90



Desktop Microphone

Multimedia condenser type microphone. Compatible with all PC sound cards.

CNA#	1-9	10+
88-500 Beige	2.40	1.90
88-491 Black	3.90	3.40



Computer Microphone

Compatible with all PC sound cards.

CNA#	1-4	5+
88-508	3.40	2.90



Power Inverter

12VDC to 110VAC. 360W continuous power. Built in thermal protection. Ideal for laptop/notebook, TV or Camcorder.

CNA#	1-4	5+
78-500	32.90	29.50





Windows Enhanced Keyboard



Features 3 Special Windows Keys. High quality keyswitch with tactile touch. A streamlined design with a small footprint.

89-129P	PS/2, Beige	5.90
89-121	PS/2, Black	5.90

Multimedia Keyboards

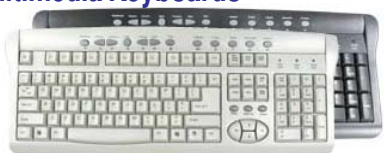

Programmable "Hot Keys". One touch access: web, volume, close, shortcuts and more. Windows 98SE/NT/2000/XP

89-141	PS/2, Beige	8.75
89-142	PS/2, Black	8.75
89-155	USB, Beige	9.75
89-162	USB, Black	9.75

USB+PS/2 Flexible Keyboard



Roll-up for easy storage. Dust and moisture proof. Great for traveling! Windows® 95/98/2000/ME/XP compatible. CE and FCC tested and approved. Standard 104 keyboard. Lifetime: 15,000,000 keystrokes.

89-147		13.50
--------	--	-------

Microsoft Wireless Keyboard & Mouse



Get the reliability you expect from Microsoft hardware at an extraordinary price. This desktop set features long battery life, and the mouse also provides a scroll wheel.

89-087	USB, Black	39.50
--------	------------	-------

Deluxe PS/2 Enhanced Keyboard



Professional quality 105 key keyboard with excellent tactile feel. A streamlined design with a small footprint.

89-096	PS/2, Beige	9.75
89-075	PS/2, Black	9.75

Deluxe USB Multimedia Keyboard



Special design deluxe multimedia/internet keyboard. High quality membrane tactile key switch with 18 hot keys.

89-078	USB, Beige	12.75
89-088	USB, Black	12.75

High-Activity Classroom Keyboard



This value keyboard is the best in its class, combining cost-effectiveness with rugged construction. Designed for high-use, high-activity conditions with full-size soft touch keys. This keyboard offers a shock-resistant design with extra-secure key caps that stay on even in classrooms. Spill-proof design.

89-076	PS/2, Black	13.50
--------	-------------	-------

Microsoft 121-Key Standard Keyboard



This 121-key keyboard standard keyboard features a spill-resistant design in a sleek black decor. Integrated hot key provide one-touch access to the internet and multimedia functions.

89-074	PS/2, Black	17.75
--------	-------------	-------

Visit us on the web for our complete product line

www.FastComputerParts.com

800-516-1262

44 Fax: 800-236-5672

Economy Optical Mice

Magic-Buttons for easy Internet browsing. Microsoft 2 button mouse mode compatible.



CNA#		1-4	5+
89-109	PS/2, Black	6.50	5.90
89-119	USB, Black	6.50	5.90

USB+PS/2 Optical Scroll Mice

Plug & Play for automatic detection and configuration. Highly reliable micro-switch with tactile click sound and feeling.



CNA#		1-4	5+
89-120	Black/Silver, USB+PS/2	7.20	6.75

Deluxe Optical Scroll Mice

Ergonomic shape for comfort. High performance, high quality and high resolution. Compatible with all Windows operating systems.



CNA#		1-4	5+
89-085	Black/Silver, USB+PS/2	7.50	6.95

Keyboard Drawer

Under Counter type wide keyboard drawer stores all sizes of PC/AT keyboards. Folding brackets mount easily under any desktop or shelf.



CNA#		1-4	5+
89-501		16.10	15.10

Keyboard Drawer

Above Counter Type Durable metal construction. Wide keyboard drawer stores all sizes of PC/AT keyboards below monitor or CPU.



CNA#		1-4	5+
89-505		29.25	27.25

CD Lens Cleaner

This PC CLEAN CD lens cleaner safely removes dust and dirt from the laser lens.



CNA#		1-4	5+
89-907	CD	4.25	3.80
202918	DVD	5.90	5.50

Microsoft Optical USB+PS/2 Mouse

Navigate with greater ease with the convenient scroll wheel. This stylish optical mouse features customizable buttons for one-click access to commonly used files and functions.



Compatible with all Windows Operating Systems.

CNA#		1-4	5+
89-072	Black, USB+PS/2	15.50	14.90

Wireless USB Optical Mouse

Cordless optical scroll-mouse. Line of sight not required with receiver. Optical sensor system stays precise, no moving parts to clean. Compact receiver.



Compatible with all Windows Operating Systems.

CNA#		1-4	5+
300115		14.75	14.25

USB Flex Lights

Plugs directly into any USB port, no external power needed. Uses less than 90 seconds per hour of battery charge. Fits easily into your notebook case with 100,000 hour lifetime.

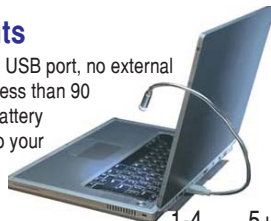

CNA#		1-4	5+
87-624	Gooseneck	5.50	4.90

Mouse Pads (10" x 8.5" x 1/4")

Made of static safe foam and canvas.

CNA#		1-4	5+
89-951bk	Black	1.19	.99
89-951g	Gray	1.19	.99
89-951bl	Blue	1.19	.99
89-951r	Red	1.19	.99



www.FastComputerParts.com

PC Anti-Static Mats

Made of durable, easy to clean vinyl. Includes ground cable.



CNA#		1-4	5+
89-915	Keyboard (11.5" x 22")	10.65	9.90
89-910	PC (20" x 24")	11.90	10.90



Power Cords

Standard, 18-3



CNA#		1-9	10+
85-380	6 ft. UL Approved, Black	2.10	1.85
85-383	6 ft. UL Approved, Gray	2.10	1.85
85-381	12 ft. UL Approved, Black	3.65	3.25
85-377	6 ft. UL Right Angle, Black	2.85	2.40

6' Monitor Cord

For connecting monitor to power supply.



CNA#		1-4	5+
85-360	UL Approved	2.05	1.80

12" Monitor Adapter

Allows monitors with standard 3 prong plugs to plug into the power supply.



CNA#		1-4	5+
85-500	UL Approved	2.50	2.25

6' Power "Y" Cord

One cord for both monitor and computer.



CNA#		1-4	5+
85-387	UL Approved	3.45	2.90

6' Notebook Power Cord



CNA#		1-4	5+
85-388	UL Approved	3.05	2.80

UPS-Battery Back-UP Surge Protector



Now there is one product for all your peripherals. Three standard outlets and three instant battery backup outlets. Full time surge protection with Fax/Modem/Phone (RJ11/12) Line Protection. Includes

86-526	600VA / 300W	58.50
--------	--------------	-------

6 Outlet Plastic Strip Surge Protector

Includes circuit breaker, on/off switch, high impact flame retardant plastic housing. (AC 125V/15A, UL/CSA listed, 1MOV)



CNA#		1-4	5+
89-015	3' Cord	3.90	3.40
215002	6' Cord	5.60	5.25
215010	12' Cord	7.95	7.50

6 Outlet Strip w/EMI/RFI and Fax/Modem Protection

Includes plastic housing, indicator light, circuit breaker, illuminated on/off switch, and 6 ft. cord. (UL listed, 3 MOVs)



CNA#		1-4	5+
89-030		16.50	15.90

Deluxe Surge Protector

Nine outlet with AC adapter design. Lighted On/Off switch and protection indicator light. Phone/Fax/Modem and TV protection. Max energy dissipation 840 joules. 6ft. power cord.



CNA#		1-4	5+
89-046	w/TV	22.25	21.25

12" AC Transformer Jumper

Perfect for jumping from power strip to transformer. Now you can use all the outlets.



CNA#		1-4	5+
85-382		2.10	1.90

www.FastComputerParts.com

Heavy Duty Metal Case Power Strip

6Ft 14AWG Power Cord, 125V 15Amp.

Easy cord wrap with heavy duty metal housing. UL listed with 15Amp circuit breaker.



215017	4 Regular Outlets + 2 Adapter Outlets	15.75
215018	5 Regular Outlets + 3 Adapter Outlets	17.75

Visit us on the web for our complete product line

www.FastComputerParts.com

800-516-1262

46 Fax: 800-236-5672

New Products

Bulk Speaker Wire

Polarized speaker wire.
RoHS compliant.



CNA#	Length	Gauge	Price
203655	50'	Polarized, 22 Gauge	2.50
203656	100'	Polarized, 22 Gauge	4.75
203657	1000'	Polarized, 22 Gauge	45.00
203642	50'	Polarized, 18 Gauge	3.50
203643	100'	Polarized, 18 Gauge	6.50
88-319	1000'	Polarized, 18 Gauge	89.00
203622	50'	Polarized, 16 Gauge	6.20
203623	100'	Polarized, 16 Gauge	12.40
88-317	1000'	Polarized, 16 Gauge	119.00
203610	50'	Polarized, 14 Gauge	8.90
203611	100'	Polarized, 14 Gauge	17.90
203612	500'	Polarized, 14 Gauge	89.00
203602	50'	Polarized, 12 Gauge	15.20
203603	100'	Polarized, 12 Gauge	30.00
203604	500'	Polarized, 12 Gauge	146.00

Flat Cat6 Patch Cables

32AWG Gold Plated.
RoHS compliant.



CNA#	Length	Color	Price
100732BK	1'	Flat, 50 Micron, Black	1.20
100735BK	3'	Flat, 50 Micron, Black	1.38
100737BK	5'	Flat, 50 Micron, Black	1.54
100739BK	7'	Flat, 50 Micron, Black	1.72
100740BK	10'	Flat, 50 Micron, Black	1.96
100741BK	15'	Flat, 50 Micron, Black	2.42
100743BK	25'	Flat, 50 Micron, Black	3.30
100745BK	45'	Flat, 50 Micron, Black	5.04

3P XLR Microphone Cables

XLR male plug to 1/4"
male microphone plug.



CNA#	Length	Price
203191	6' Mono Cable	2.50
203192	10' Mono Cable	3.10
203194	25' Mono Cable	5.66
203195	50' Mono Cable	9.82



Terms: Minimum Order \$20.00 All returns must have RA#. Freight FOB Dayton, OH. Payment: Mastercard, Visa, Discover, American Express & COD. Memory, CPUs, Software and Test Equipment are non-returnable. This catalog supersedes all previous publications. All information in this catalog is believed to be correct. CNA assumes no responsibility for the accuracy of this publication. Liability limited to refund or replacement only. Prices subject to change without notice. Copyright May 2009 Computer Network Accessories, Inc.

Custom Printed Computer Case and Keyboard Badges

Quality full color custom computer case and keyboard logos. Crystal clear 3-dimensional 1/16" high flexible dome protects your logo from wear and tear.

Self-adhesive backing.

CNA#	100+	300+	500+	1000+	2000+
85-762 Case	.94	.77	.63	.57	.45
85-767 Keyboard	.94	.77	.63	.57	.45

For complete details on our logo products visit www.FastComputerParts.com

Keyrings for a Standard Case Badges

This keyring has a insert for a standard 1" x 1" case logo. Makes a great giveaway for case logos you already own or have us make your logos. Logos sold separately.



CNA#	100+	300+	500+	1000+	2000+
85-780 Keyring	.59	.54	.50	.45	.39

PC Case Logo's



CNA#	1-24	25+
85-765 Custom Built PC	.99	.79
85-769 Quality Built Systems	.99	.79
85-761 CNA Computer Systems	.99	.79

800-516-1262

www.FastComputerParts.com



DATA CABLING

CABLE MANAGEMENT

NETWORK HARDWARE

USB PRODUCTS

PC CABLING

HDMI CABLING

VOICE CABLING

VIDEO CABLING

AUDIO CABLING

SURVEILLANCE

TOOLS & TESTERS

PRINTER SUPPLIES

PC HARDWARE

INSTALLATION PARTS

MULTIMEDIA

KEYBOARDS & MICE

Tools and Testers



Connectors



starting at
52¢

USB Products



starting at
\$5.90



Computer Network Accessories, Inc.
5520 Burkhardt Rd - Dayton, Ohio 45431-2148



Bulk Wire

starting at
\$34.50

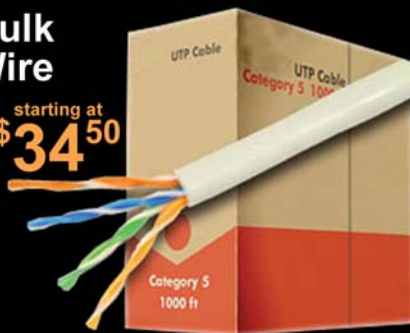

Wireless Networking

starting at
\$39.00



800.516.1262
www.FastComputerParts.com